



SEABORG 1200MJ

Instruction Manual

Caution

This document contains important instructions for using your electric reel. Please be sure to read them thoroughly before use.

About the signs



This sign means "prohibited actions." Within the area or near this sign, specific prohibited actions are described.



This sign means "actions that require caution." Within the area or near this sign, specific actions that require caution are described.



This sign means "mandatory actions." Within the area of this sign, specific mandatory actions are described.

WARNING

The following pertains to matters that could cause problems or serious, even life-threatening injuries should the instructions be ignored or incorrectly followed.

-Be careful not to catch your fingers between the reel and the level wind, which is used to wind line into the spool evenly. It may cause injury.



Hands off!

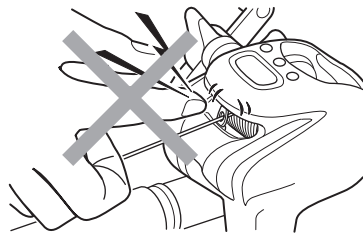

-When you turn on the clutch while feeding line (operated by the motor), it winds up the line. Be careful not to catch your fingers. It may cause injury.



Hands off!

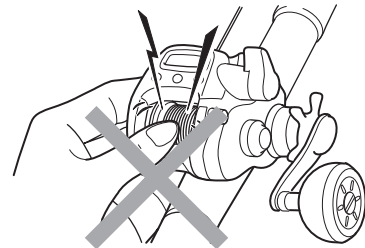

-Adults or parent's must supervise closely any use of this product by children. Use extreme caution to keep their fingers and hands away from moving parts or openings in the reel.



Cautious handling!

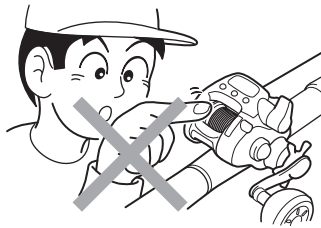

-When using batteries or the power supply of a boat, only apply the designated voltage. Other voltage may cause an abnormally high temperature in the electric reel, that could burn your hand or damage the microchip. Do not connect to house current or any AC (alternating current) power supply. The circuit may be short-circuited and result in smoke and fire.



Do not use!

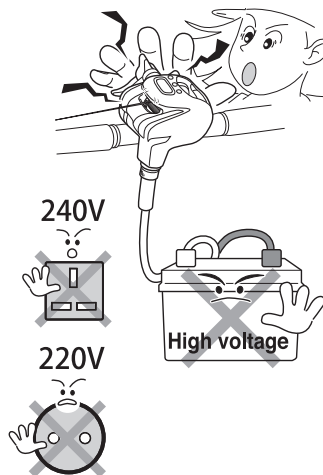

-Do not use and keep this product within the reach of children.



Secure storage!



Index

Caution	1-7	Reel Specifications	45
		Reel Specification list	45
		Counter display	45
Power source	8,9	Parts List	46
How to connect the power source	8	Trouble shooting	47
About the power source	9		
Battery level indicator	9		
Maintenance	10,11		
About maintenance	10		
Maintenance procedures	10		
Handling and maintenance of the power cord	11		
Maintenance of the power cord	11		
Other maintenance points	11		
Names and functions of each part	12,13		
Names of the buttons and the display	14		
Functional setting	15-44		
1. How to operate the Menu screen	15,16		
Setting of useful functions	15,16		
2. Main line input	17-26		
P1 Line Input	17-19		
P2 Backing line input	20-23		
P3 Line re-input	24-26		
3. Sub counter	27-29		
Inverse counter	27		
Winding speed	28		
Time to wind up	29		
4. Before start fishing	30		
Water surface zero setting	30		
If the main line is broken	30		
5. Auto stop	31,32		
Adjustable auto stop setting	31,32		
6. Pickup / Pause	33		
7. Jigging	34-36		
8. Chumming Timer	37		
9. Chumming Timer Winding	38		
10. Water depth recalibration	39		
11. Actual fishing history	40		
12. How to fix the rod with clamp	41		
13. How to remove the handle knob	42		
14. Other useful functions	43,44		
Various alarms	43		
Alarm sound ON/OFF setting	43		
Drag sound ON/OFF setting	43		
Language setting	44		
Unit setting	44		
Counter lamp	44		
Circuit breaker display	44		

List of options for line data input

This reel can be configured and set-up using the following options.

P1 Line Input 17-19

This option allows you to set useful functions when you know the length of the fishing line to be wound on the reel.

P2 Backing line input 20-23

This option allows you to set functions to insert a backing line. Note that it is necessary that you know the line length and that it is greater than 100 m.

P3 Line re-input 24-26

This option allows you to re-enter the line data, pulling out the line after it has been completely wound up onto the reel. Note that it is necessary that you know the line length and that it is greater than 100 m.

Thank you for purchasing a SEABORG 1200MJ. Please read this operation manual carefully and use the product safely and correctly to take full advantage of this electric reel with many convenient features for your on-board fishing. Please keep this operation manual carefully together with your reel for your future reference.

Caution

⚠ WARNING

The following pertains to matters that could cause problems or serious, even life-threatening injuries should the instructions be ignored or incorrectly followed.

-The electric reel causes a small amount of electric waves that could cause malfunction of electronic medical devices such as hearing aids, cardiac pacemakers, etc. Those who have a cardiac pacemaker may feel palpitations and dizziness when using an electric reel, so confirm with the manufacturer of your medical device or the distributor regarding the influence of electric waves prior to use of this product.



Cautious handling!



-Do not fasten an electric reel with a harness onto your body. You may risk your life if pulled into the seawater by a big fish or in other situations.



Do not use!



⚠ CAUTION

The following pertains to matters that could cause problems or serious, even life-threatening injuries should the instructions be ignored or incorrectly followed.

-Do not touch moving parts while in operation. It may cause injuries.



Hands off!

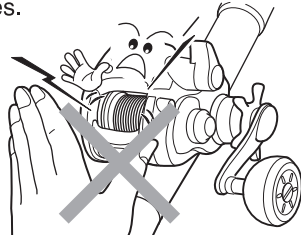

-Should water droplets get inside the liquid crystal, it could cause the microchip to malfunction and keep the motor turning. In such a case, stop using this product and have it repaired immediately.



Do not use!

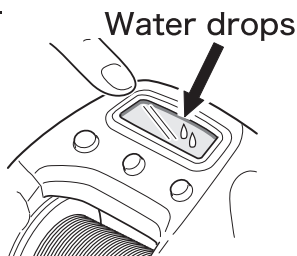

-Should the motor fail to stop for some reason while fishing, use caution to prevent your fingers being caught in the reel. Disconnect the power supply immediately.

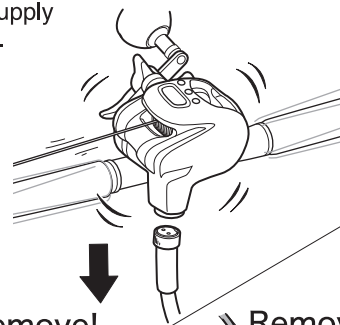

Remove power supply!

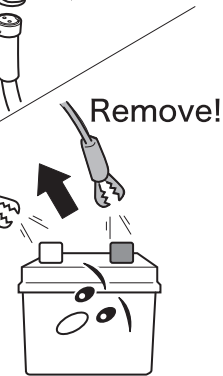

Caution

⚠ CAUTION

The following pertains to matters that could cause problems or serious, even life-threatening injuries should the instructions be ignored or incorrectly followed.

-Before adjusting drag tension, always turn off the automatic electric winding. You could cut your hand when pulling line to check tension.



Turn off!

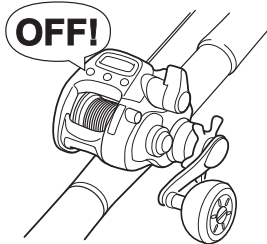

-When not tending this product, turn the power off (Power Lever back) and remove the power supply to prevent it starting accidentally and causing injuries.

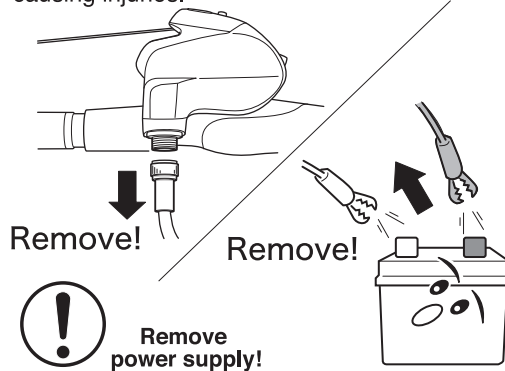

-Do not touch or grab the line when it is being released or wound rapidly. The line may cut your fingers.



Hands off!

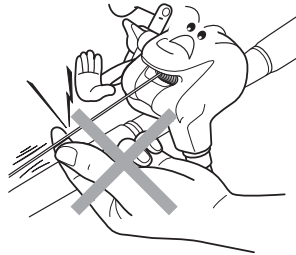

-A damaged cable may disrupt operation or short circuit and cause other problems depending upon the conditions of use. Be sure to follow the instructions stated in "Cable Handling Manual," "Cable Maintenance Manual," and "Other Instructions for Maintenance."

When not using the cable, disconnect the power supply.

It is recommended you replace the cable with a new one every other year to maintain full performance of the reel.

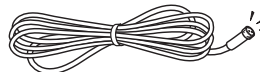

Handle it properly!



-When winding up line indoors, do so at high speed. If wound up at low speed and high tension, the motor may heat up abnormally and emit smoke. Power to wind up electronically may deteriorate.



Cautious handling!

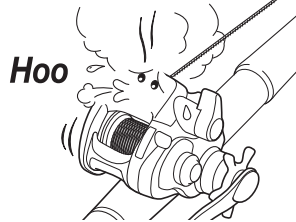

-Please be careful to keep your finger from heat radiation section of the motor and drag radiator section which is likely to be high temperature and may cause a burn.

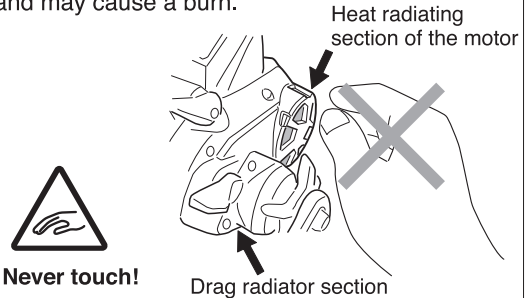

Never touch!

-Before reconnecting the power cable on the boat, thoroughly wipe away any moisture such as saltwater from the connecting parts with a dry cloth. If you connect it wet, it may short-circuit causing electric shock, smoke, or even fire.



Cautious handling!

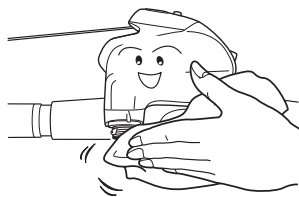

アフターサービスについて

本製品は当社の厳重な検査を経て出荷されたものですが、万一、故障が生じ修理が必要な場合、あるいは部品御注文の際は買い求めの販売店、または下記のお客様センターまでお問い合わせください。なお、修理品は部品代のほか手数料をいただきますのでご了承ください。

お客様センター（無料） 携帯電話からもご利用できます

TEL **0120-506-204**

受付時間：9:00～17:00（土・日・祝祭日は除く）

ホームページ上からもご確認、お問い合わせできます

www.daiwa.com/jp/

グローブライド株式会社

〒203-8511 東京都東久留米市前沢3-14-16

Caution

⚠ CAUTION

The following pertains to matters that could cause problems or serious, even life-threatening injuries should the instructions be ignored or incorrectly followed.

-When your hook is caught in the bottom, do not jerk the rod to free it. Pull the line with your hand and cut it if it fails to pull free. (Be sure to protect your hands with gloves or a towel.) If you use thick leader and cannot cut it with hands, talk to the captain for a safe treatment.



Risk of injury!



-In case you smell burning or you find other troubles, stop the motor and remove the power supply. It may cause heat or fire.

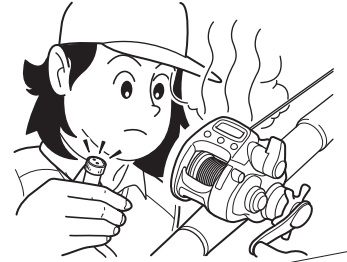

Remove!



Remove power supply!

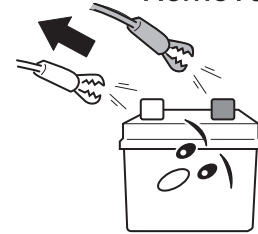

-Before connecting it to the power supply, be sure to loosen the drag well. If the IC breaks, and the motor does not stop, the terminal rig may be wound into the reel and the rod may break.



Required handling!

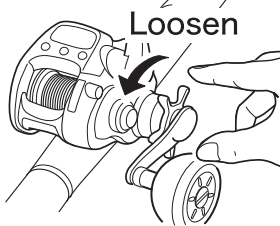

-Handle it cautiously as to not to stain your clothes with grease or oil from moving parts.



Cautious handling!



-Use the reel only for the purpose of fishing.



Never use it for other purpose!

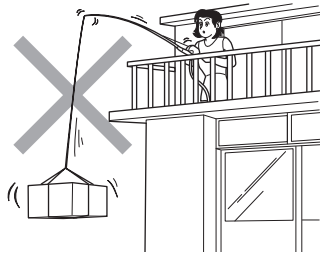

-Do not touch parts where the surface or top coatings (such as paint) are peeled off. It may cause injuries.



Hands off!



-Do not use wire line with your reel. It may cause corrosion or damage to the spool.

Screech!



Do not use!

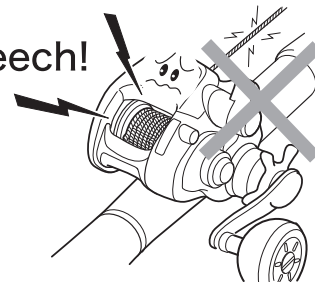

Caution

⚠ CAUTION

The following pertains to matters that could cause problems or serious, even life-threatening injuries should the instructions be ignored or incorrectly followed.

-Do not wind up with excessive force when line is tangled with other angler's lines or snagged on the bottom. It may cause damage to your rod and other components.



Handle with care!

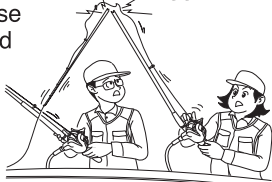

-Excessive shock, as from dropping, may cause malfunction with breakage or other damage to the internal electronic components such as cracks that allow water entry or short circuiting of circuit boards. Use care to avoid strong shocks and pressure (It may cause problems even though damage may not be visible.)



Handle with care!

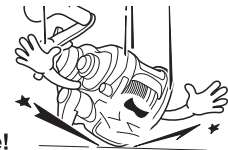

-Do not dismantle or modify the reel. It may deteriorate the performance of the reel or cause other problems.



Do not modify!



-Reset the counter whenever it displays the wrong number, you have cut off line, disconnected the power supply or changed line tests. If you use the reel without resetting the counter, your terminal rig may be pulled into the reel and break the rod or other components. Forgetting to reset it with your terminal rig at the water surface may cause the same problem.



Required operation!

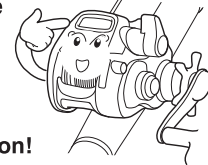

-Do not modify the cable. It may cause a short-circuit or other problems and could result in smoke or fire.



Do not modify!

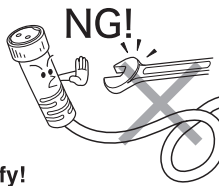

(MAGSEALED mounted model) INSTRUCTIONS FOR HANDLING

This document contains important instructions regarding special attention that may be required when using an electric reel. Please be sure to read them thoroughly before use.

■ MAG SEALED

MAG SEALED is a revolutionary mechanism designed to make a wall with magnetic fluid and keep water out. While maintaining smooth rotation, it sustains the initial rotation performance for a long time by keeping out water and foreign substances. The elimination of annoying salt adhesion can remove degraded rotation or noise created during long-term use, resulting in significantly improved durability.

■ MAG SEALED ball bearing

Our unique technology has turned the ball bearing itself to MAG SEALED. The wall of magnetic fluid prevents water or foreign substances from entering the inner ball bearing, which substantially eliminates noise and rust or salt adhesion on the ball bearing.

⚠ Attention

- Never lubricate the MAG SEALED ball bearing to avoid the loss of the MAG SEALED function.
- Never disassemble the ball bearing to avoid the loss of the MAG SEALED function.

⚠ Attention

- The excellent rustproof and dustproof performances of the MAG SEALED ball bearing are provided by the wall of magnetic fluid (MAG OIL) enclosed in the ball bearing.
- MAG OIL enclosed slightly greater in quantity could seep out of the ball bearing surface, but it will not affect performances. (Do not wipe off the oil seeping out of the surface.)
 - Never touch or wipe the MAG SEALED ball bearing with your finger, cloth or a cotton bud. Wiping off MAG OIL could impair the MAG SEALED function.

Caution

INSTRUCTIONS FOR HANDLING

This document contains important instructions regarding special attention that may be required when using an electric reel. Please be sure to read them thoroughly before use.

! ATTENTION

-Do not step on or place objects upon the reel. It may cause problems with the reel.

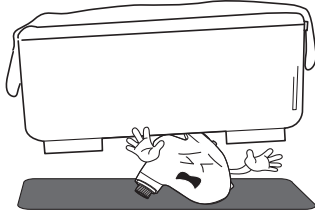

-Do not leave the reel near heating appliances. Resin may melt and deform or deteriorate causing problems.

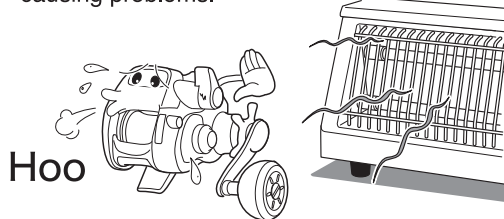

-Do not insert a stick or metallic object into the opening between the spool and the frame or other parts of the reel. It may cause problems with the reel.

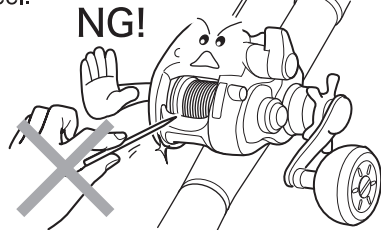

-When storing the reel for a long time, wipe down the moisture completely and preserve it in as well a ventilated place as possible without direct sunlight. Loosen the drag when storing it.

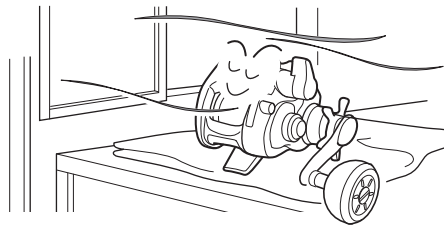

-Before removing the power supply, turn off the power (power lever back) as it could cause problems with the reel.

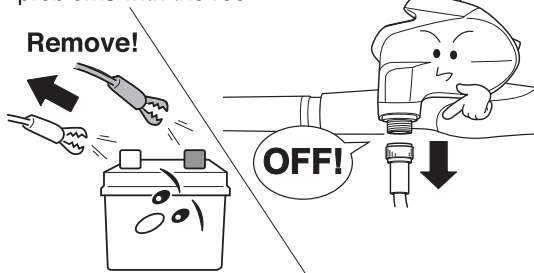

-When the reel is stored with the wet line with salt seawater, the spool may rust. Wash only the spinning part with tap water to rinse off seawater sufficiently, and then dry it in a well ventilated place without direct sunlight before storing it.

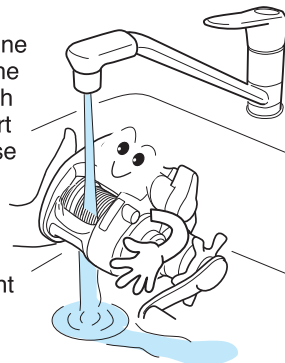

-Before going fishing, please check the reel for proper operation to ensure an enjoyable fishing trip.

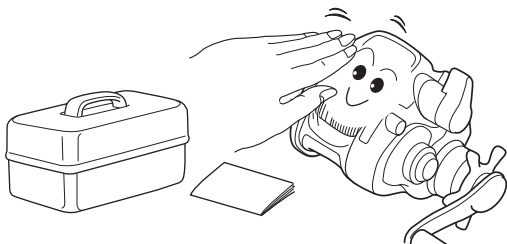

-Do not store a wet reel in a plastic bag or a fishing bag because it may cause rust or malfunction.

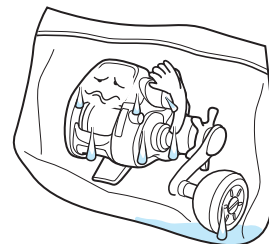

Caution

⚠ ATTENTION

-Use neutral detergent (dish washing detergent) when washing the electric reel. Do not use chlorine, acidic, or alcohol type cleaners. It may deteriorate resin and cause problems with the reel.



-Be cautious not to let cloth or other objects become caught in the reel when winding. Be careful not to have the line slackened by backlash or other cause caught into the reel.

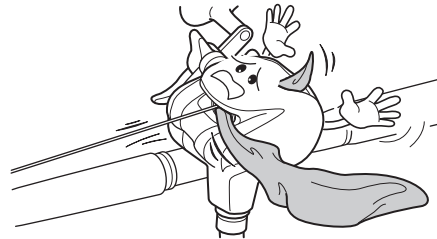

-Unplug the power supply and the cable when not in use.



-Do not store the reel with tightly-wound, damp line. During storage, the line may dry up and shrink, resulting in damage to the spool. Do not wind nylon or fluorocarbon line onto a model designated exclusively for PE line (braided line).

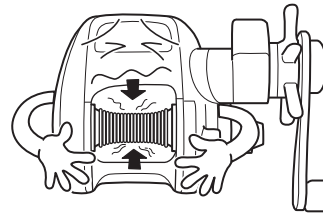

-Do not put a magnetic item such as magnet closer to the product. Otherwise, it malfunctions or causes failure.

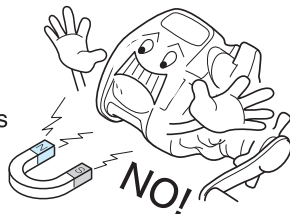

-When fixing the rod into a hole on the boat edge with the reel attached, verify that the reel does not touch the edge. When it touches, do not place it into the hole. The reel may be damaged.

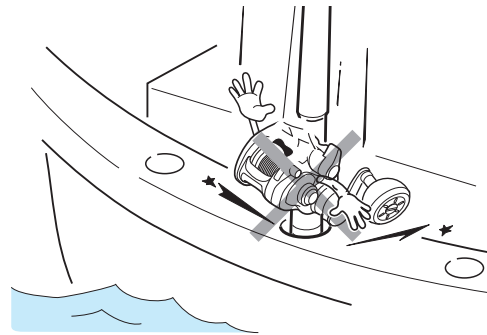

-When shrinking a telescopic rod, do not tap rod butt on the ground with the reel attached. The reel may be damaged.

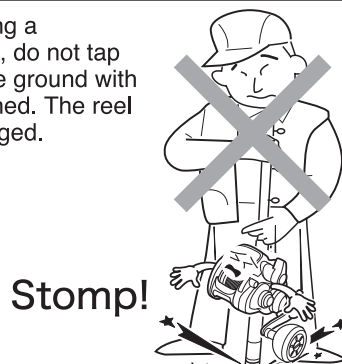

◆ About the counter display

The following conditions may make the display difficult to read.

1. Wearing polarized glasses.
2. Excessively cold or hot weather, mid-winter (display's surface temperature is below -10 degrees centigrade) and mid-summer (display's surface temperature is above 60 degrees centigrade).
3. When light strikes the display from certain angles, the display's digits may have shadows. This does not affect its function.

Power source

How to connect the power source

1. Attach the cord clips to the battery.
Red covered clip is the plus (+), and the black covered clip is the minus (-).
2. Insert the connector into the reel. After this, the display appears as below.
By taking the appropriate steps, the indication will change as shown below and the data will be set.

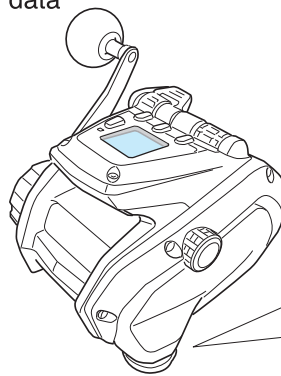
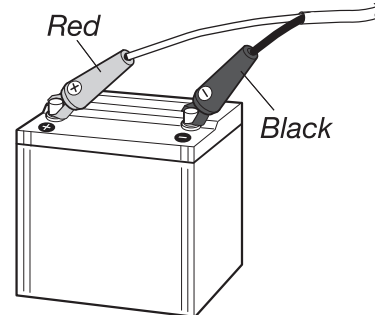

(Screen shown when the unit is turned ON)



(Screen showing the Water Depth)

Attention

When changing batteries, the display's back up memory stays active for about 15 minutes after the old battery is disconnected. Thus the above display startup sequence does not need to replay when the new battery is connected within the 15 minute time frame.

Power source

About the power source

This reel is designed to be compatible with direct current (DC) 12 Volt only. You may not use any power sources other than DC12V to power this reel (for example, AC100V from a household power supply and DC24V equipped on a boat).

The power source voltage on a boat tends to lose stability as it is largely influenced by a generator on board and wiring which may trigger the protective circuit causing sudden stop or intermittent operation of the reel. To maximize the reel performance, be sure to use the electric reel specific batteries.

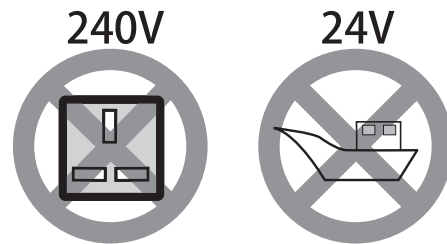

Attention

Make sure of the following before departure.

- 1. Recharge the battery before your fishing trip. Over time, a battery can naturally discharge.*
- 2. Confirm the boat can provide the proper power source (i.e. voltage, connector shape etc).*
- 3. Corroded connections can prevent the flow of electric current. Remove any corrosion or dirt from the connectors.*

Battery level indicator

When the battery voltage is lowered while powered ON, the battery level indicator becomes as shown below.

When the voltage goes down to 10V or less, the winding power of the reel is restricted and the maximum performance cannot be gained.

If this indicator is blinking while the motor is not running, battery voltage may be low due to decreasing of the residual capacity of the battery. If it is blinking, replace the battery with a recharged one (If you use the on-board power supply, check the voltage and the terminal of your boat).

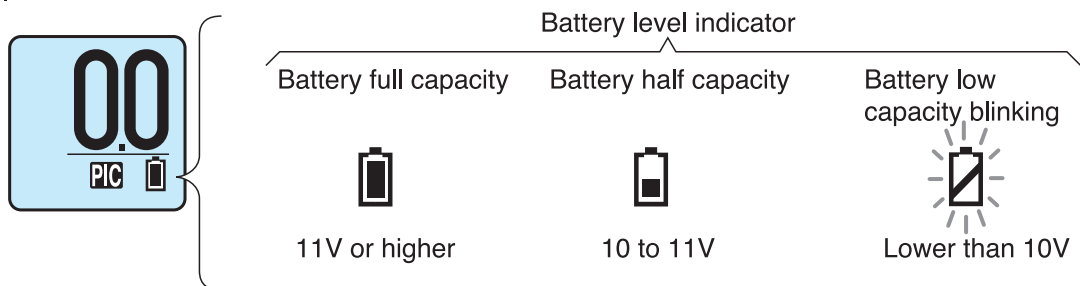

*There may be a slight difference between the reel detection voltage and the actual voltage of the power supply.

*When the battery runs out and the counter display goes out, be sure not to operate your electric reel manually to wind the line and be sure to replace the battery with a recharged one before doing any operations (relating to fishing). Any manual operation in such condition may cause the water depth counter to go out of order, resulting in the tip of fishing rod being broken due to accidentally winding up all the line when you restart an electrical winding later with a replaced battery.

Maintenance

About maintenance

This is a washable reel. Wash away salt residue and grit after fishing.

Maintenance procedure

1. Wash the reel with a dish washing detergent and a soft sponge. Do not use solvents.

Do not use soap or other detergents. Other soaps or solutions may damage the reel both externally and internally. The solution may damage the outside coating of the reel and may breakdown the grease inside of the reel creating an overflow of grease.

2. Rinse detergent and dirt away with running water, rinsing the spool very well to get rid of salt. Use warm water, under 30 degrees centigrade.

3. Dry the reel well.

*Loosen the drag when stored.

*Be sure to remove water from inside the handle knob, because water could build up there.

4. Feed oil.

Spray oil on the worm shaft.

*Recommended grease: Genuine reel guard grease (product code: 04980020)

Get the specific spray from a fishing-tackle store.

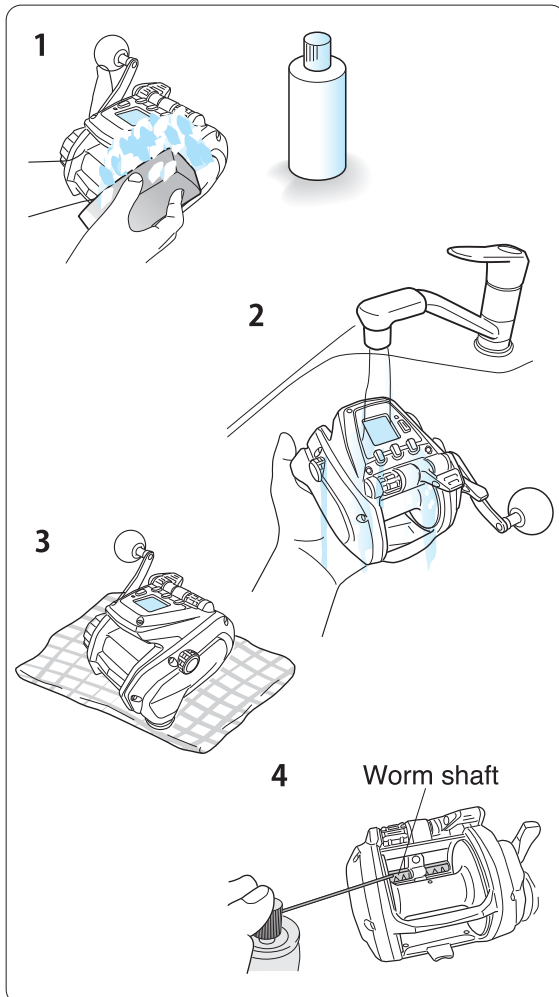

Attention

1. Do not wash with seawater or soak in water.
2. Do not use organic solvents such as benzene and thinner.
3. Do not use a steel brush or abrasive cleanser.
4. The fed oil may spring back and squirt. Do not peer down the worm shaft part.
5. Do not feed oil to water discharge hole.
6. Do not put magnetic force closer to the product main body.

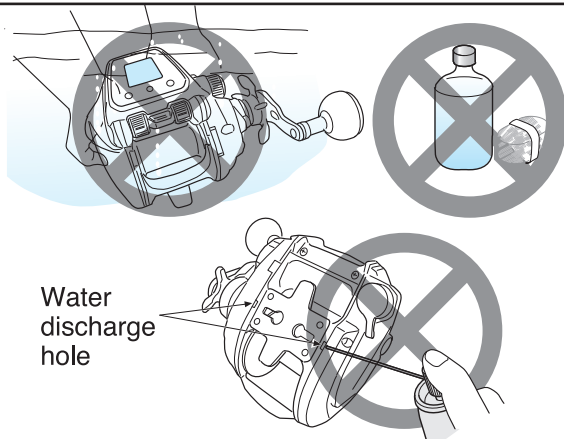

Maintenance

Handling and maintenance of the power cord

Follow the restrictions below to avoid troubles caused by disconnection of power cord and the like. Be sure to use the specific power cord supplied with the reel unit.

*Note that the unit is not compatible with any other power cord.

*Do not modify the power cord. It may cause an unintended failure. Be sure to keep the power cord intact.

- Do not hang the reel by the power cord.
- Do not wind the power cord around the reel body with the connector inserted into the reel.
- Do not wash the power cord.
- Do not set heavy items on the power cord, or tie knots in the power cord.
- If any abnormal events occur, including smoke and abnormal odor, stop the use of the power cord and remove it immediately from the battery.
- Note that the inner electric cable may be disconnected or broken despite of no visible damage on the appearance, if you step on the power cord, or if you pull the power cord strongly when it is trapped with cargoes, during use.

Maintenance of the power cord

- Wipe the power cord with a wet cloth and dry it well.
- Pay special attention to drying the tips, with cover removed.
- Grease the connector after it is dried.
- Disconnect the power cord from the reel before storing.

Hold the connector, not the power cord, to pull the power-cord from the reel.

Clean and grease area A (pins) and area B (Circumferential area).

Other maintenance points

- This reel is a precision instrument that employs electric circuitry and motor. Do not disassemble the reel by yourself.
- Cover the power connector on the reel with its protection cap.
- Old or worn cords can cause a bad connection and/or short circuit. Replace the cord every 2 years.

Names and functions of each part

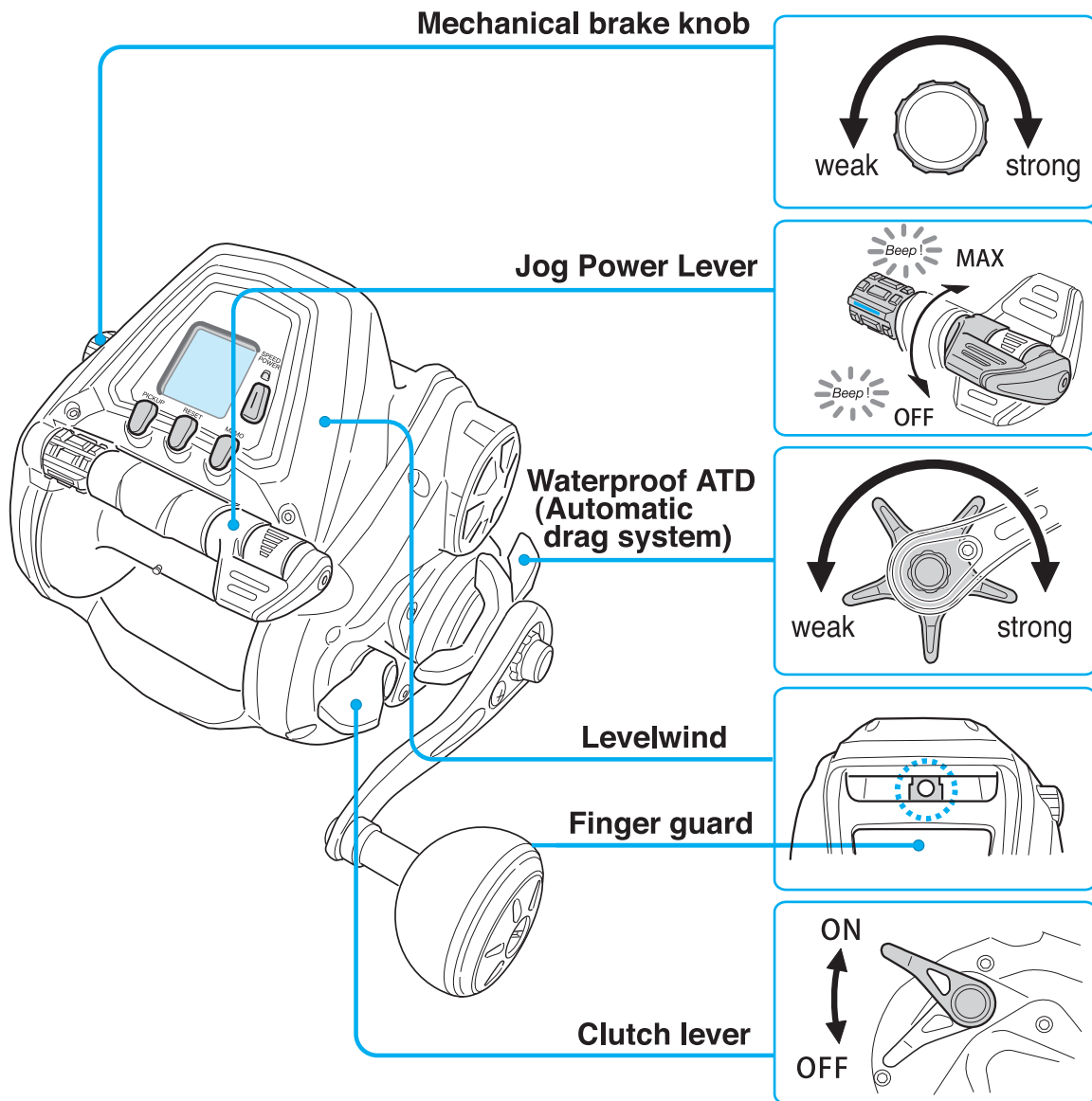

Accessories

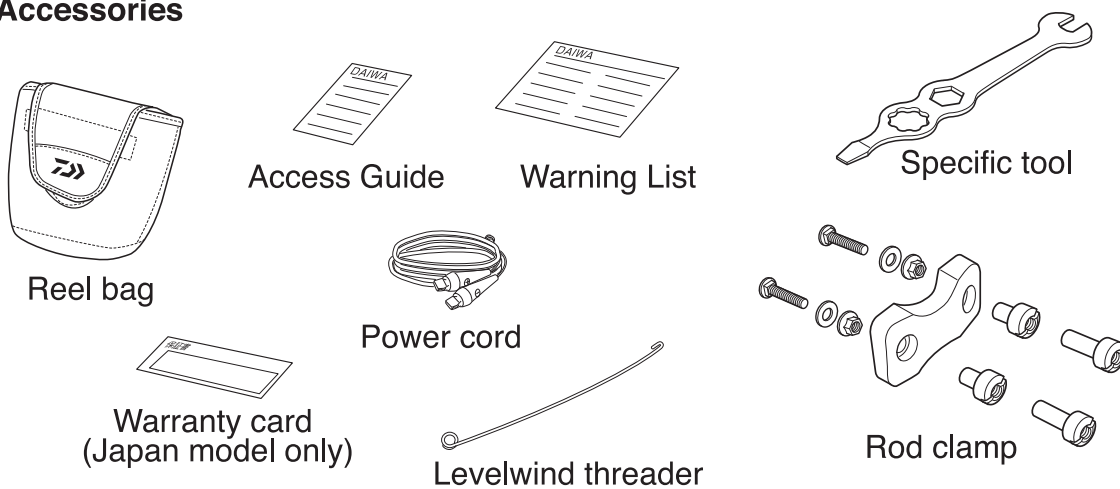

Names and functions of each part

Jog Power Lever

- You can move the right lever by pinching it with your thumb and forefinger.
- Left side rotary lever can be rotated with your thumb.

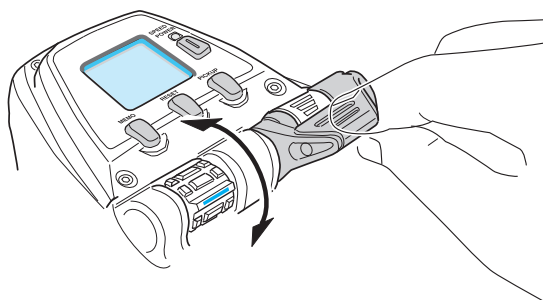
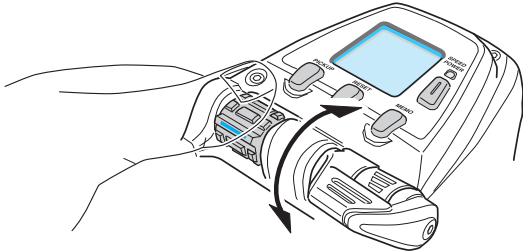

- You can freely adjust the winding power or the winding speed from OFF to MAX by using the lever.
- Turning the lever forward (toward MAX) will increase the winding power. Turning the lever back (toward OFF) will decrease the power.
- Check the position of the lever before you start winding. If it is not at OFF position, turn it back to OFF position (an audible alarm will sound to tell you that the lever has backed to the OFF position). Then, push the lever forward to start winding.
- Note that the lever does not accept your lever manipulation near the pre-set auto stop point for safety reasons.
- The displayed value for setting by the lever may fluctuate due to winding load fluctuation but it is not abnormal event.

Waterproof ATD (Automatic Drag System) * With a drag click system

- This is designed to provide a mechanism whereby adjusting the star drag allows the spool to slip against a strong pull to avoid line breakage.
1. Set the reel on the rod and put the line through the rod guide before adjusting the drag.
 2. Adjust the tightness of the drag, with the clutch ON, manually pulling the line out from the reel. Normally, adjust the drag allowing the spool to slip before the line breakage (trace line).

Clutch lever

- You can move the right lever by pinching it with your thumb and forefinger.
- Left side rotary lever can be rotated with your thumb.

Mechanical brake knob

- This allows you to adjust the lowering speed of the terminal rig to prevent backlash. Adjust the tightness depending on the conditions such as rolling of your boat and the rig weight.

Levelwind

- The levelwind allows to ensure an even winding of the line on the spool that is passed through the guide.
- *The line may be wound unevenly on the spool depending on the winding condition in some cases.

Accessories

- Power cord
- Reel bag
- Specific tool
- Rod clamp
- Access Guide
- Warning List
- Warranty card(Japan model only)
- Levelwind threader

Names of the buttons and the display

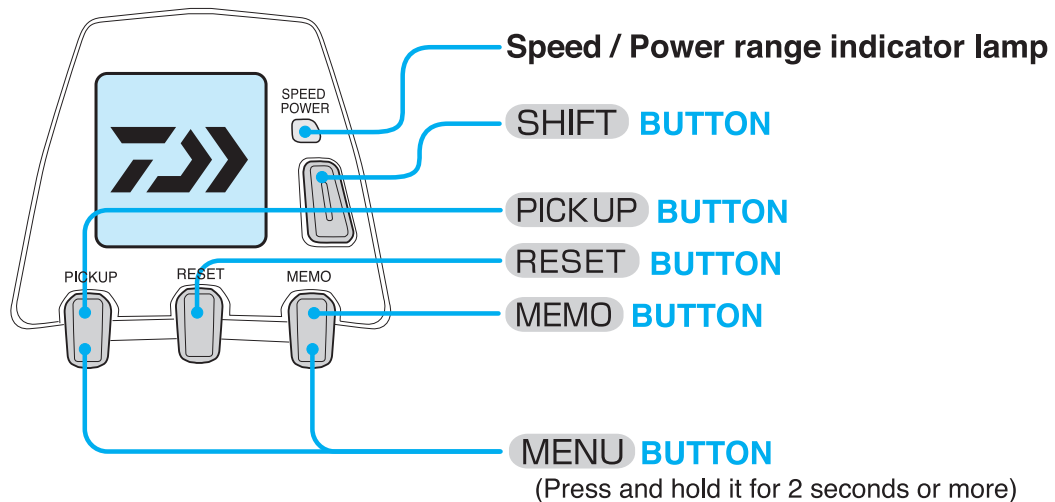

● RESET

- Press the **RESET BUTTON** once always before you start fishing.
- The auto stop position is set based on the point where you pressed the **RESET BUTTON**.
- Pressing and holding this button for 2 seconds or more allows you to correct the data when the line has broken.

● MEMO

- This button is used to reset the inverse counter or resume the chumming timer.
- Pressing and holding this button allows you to set the auto stop point.
- This button acts as **OK BUTTON** in the Menu screen.

● PICKUP

- The button is used to execute Pickup, Pause and Jigging.
- This button acts as a **(RETURN) BUTTON** in the Menu screen.

● MENU

- Simultaneously pressing and holding both **MEMO BUTTON** and **PICKUP BUTTON** for 2 seconds or more will open the screen where you can set various convenient functions.

● SHIFT

- This button allows you to shift between the Speed Range and the Power Range.
- The Speed / Power range indicator lamp lights green in the Speed Range mode. In the Power Range mode, the lamp lights red.

Functional setting [1. How to operate the Menu screen]

Setting of useful functions

-The Menu provides various useful functions for your fishing.
 *Once you have set up a parameter, it is saved in the memory for your next fishing.
 (Settings may not be saved in the memory if you turn off the power immediately after setting)

1. When the display shows **0.0** press and hold both **MEMO BUTTON** and **PICKUP BUTTON** simultaneously for 2 seconds to show the Menu screen.

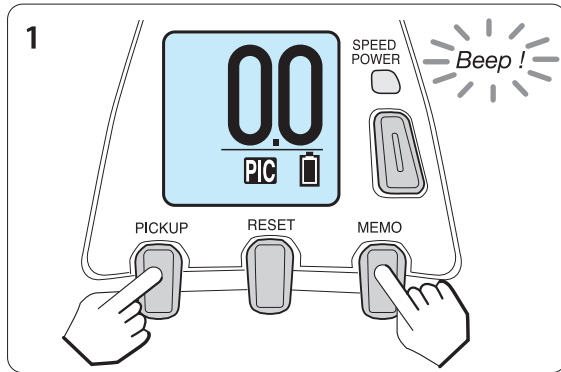

(Water Depth screen)

MEMO BUTTON +
PICKUP BUTTON (Press and hold)

2. Select a parameter using the Jog Power Lever and press **OK** (**MEMO BUTTON**) to go the screen for setting.

*For details on setting of each pages, please refer to the following pages.

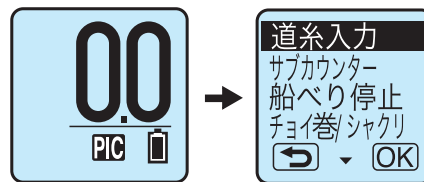

(Water Depth screen) (Menu screen)

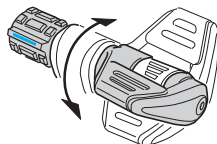

You can select your desired parameter using the Jog Power Lever.

道糸入力	→	See P17 - 26
サブカウンター	→	See P27 - 29
船べり停止	→	See P31 and 32
チョイ巻/シャクリ	→	See P33 - 36
タイマー巻上	→	See P38
アラーム音	→	See P43
ドラッグ音	→	See P43
水深補正	→	See P39
実釣来歴	→	See P40
Language(言	→	See P43
単位	→	See P44

Functional setting [1. How to operate the Menu screen]

■ Operation in the Menu screen

Here, the Menu screen is used as an example to how to operate the screen.

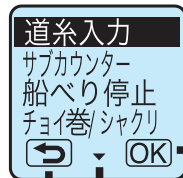

OK BUTTON

This shows that you can confirm the choice here. If you confirm it OK, press the MEMO BUTTON to go to the next screen.

If ▲ or ▼ is displayed, you can select any parameter by scrolling the screen with the Jog Power Lever.

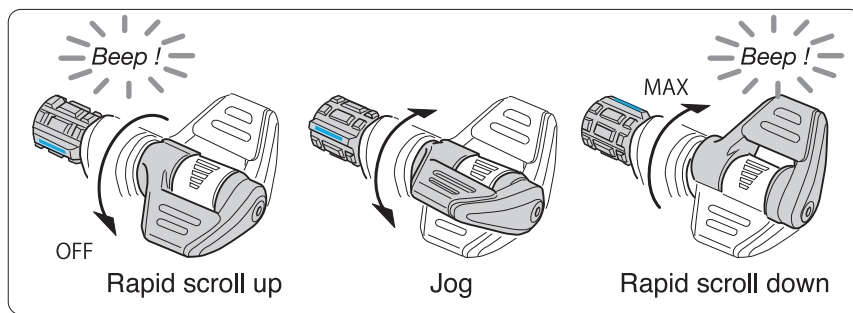

(RETURN) BUTTON

This shows you can return to the previous screen. If you desire to return to the previous screen, press PICKUP BUTTON.

3. Once the settings have been completed, return to the Water Depth screen to start fishing.

Functional setting [2. Main line input]

P1 Line Input

This function is convenient when you know the length of the fishing line to be wound on the reel.
(The following example explains how to insert a PE 100lb-800m fishing line.)



Watch out for Burns!

An overly heated motor may cause the frame to become very hot, so do not touch it directly when inserting the main line. Insert the line while holding the frame with a wet towel, etc.

1. Pass the main line through the Level Wind and tie it to the spool.

- *The enclosed threading pin (See P12) facilitates the process.
- *Make sure to tie the line to the line stopper to prevent the line from slipping on the spool.
- *Tighten the drag.

2. Return the Jog Power Lever to OFF.

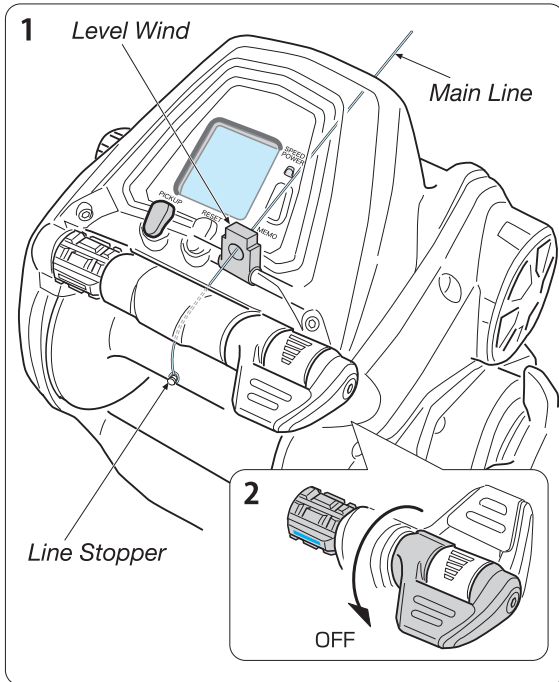

3. Turn on the reel.

- *Please refer to the page 8 “How to connect Power Supply” for the details of the connection method.



(The screen when the reel is switched on)

4. When **0.0** is displayed, press and hold the switches **MEMO** **BUTTON** and **PICKUP** **BUTTON** simultaneously for 2 seconds.

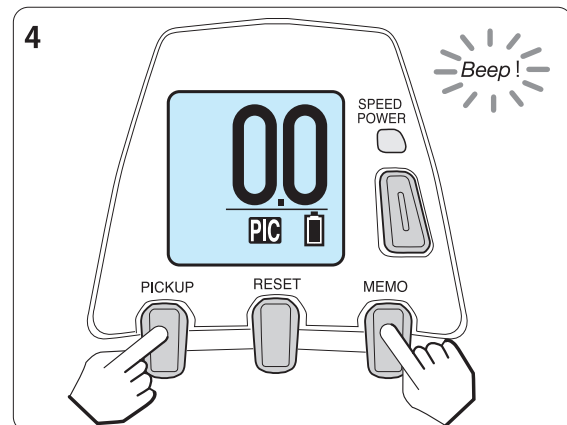

(Water Depth Screen)

Functional setting [2. Main line input]

P1 Line Input

5. Select “Line Input” with the Jog Power Lever and press **OK** (**MEMO BUTTON**).

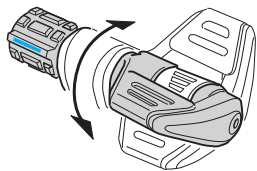

*By moving the Jog Power Lever, the selected item is highlighted on the screen.

*When the scrolling text 《Do you wish to continue?》 is displayed, press **OK** (**MEMO BUTTON**) one more time.

6. Select “Line Input P1” and then press **OK** (**MEMO BUTTON**).

*The screen automatically switches to “Speed Range”

7. After adjusting the tension, turn the Jog Power Lever to the MAX position and then wind the main line.

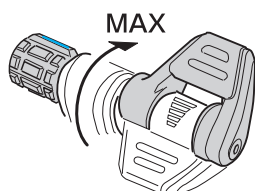

*While winding up the line, try to adjust the tension so that the mark ▼ stays around the screen center.

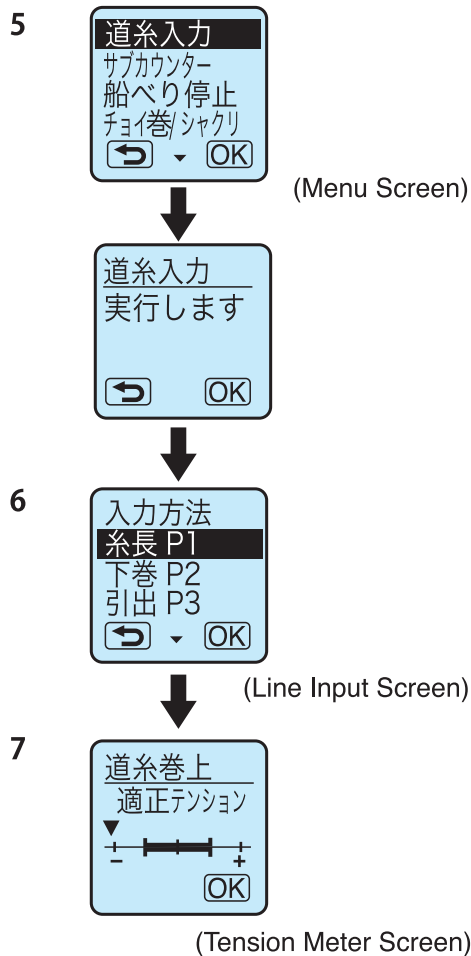

Attention

- The reel may be damaged if the line touches the finger-guard or the frame. Keep the line from touching these components.
- Winding the line indoors for a prolonged period at a low speed with an elevated tension may cause the motor to overheat and thus fail. When winding the line, turn the Power Lever to the MAX position on the Speed Range screen. When actually fishing outdoors, there is no need to worry because it is cooled with seawater, etc.

Functional setting [2. Main line input]

P1 Line Input

8. When winding is complete, turn the Jog Power Lever back to the OFF position and then press **OK** (**MEMO BUTTON**) .

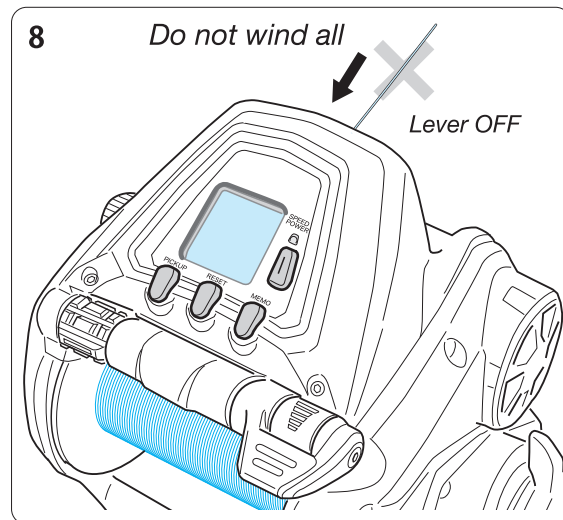
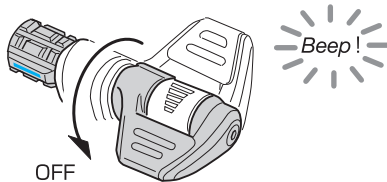

Attention

- Do not wind all the line. Before winding up all of the line, turn the Jog Power Level to the OFF position and then wind up the remaining line manually with the handle. Winding up all may cause an error with the counter.
- This winding method cannot be applied to lines thinner than PE 40lb.
- When winding a PE 40lb line, the line may enter the gap between the spool and the frame if wound close to the spool's outer diameter; so it is advisable to wind the line up to about 1mm inside the outer edge of the spool.

9. Select the line length with the Jog Power Lever and then press **OK** (**MEMO BUTTON**) .

- *The illustration shows a case of inserting 800m.
- *The default value is set at 600m.
- *The value can be set for every 10m.

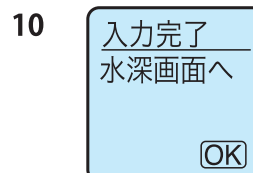
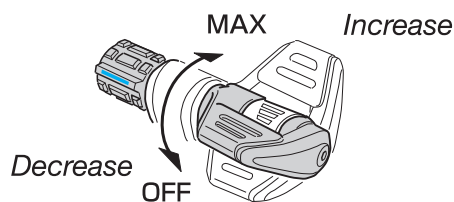

10. When "Complete" is displayed on the screen, press **OK** (**MEMO BUTTON**) and the display will return to the water depth screen to complete inserting the line.

- *When "Error" is displayed while inserting the line, press **OK** (**MEMO BUTTON**) to return to the water depth screen and re-start the process from the beginning.

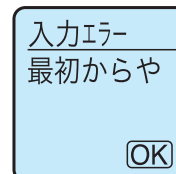

Functional setting [2. Main line input]

P2 Backing line input

Note that a 100 m or longer line of which length is known is necessary.



Watch out for Burns!

An overly heated motor may cause the frame to become very hot, so do not touch it directly when inserting the main line. Insert the line while holding the frame with a wet towel, etc.

1. Pass the main line through the Level Wind and tie it to the spool.

*The enclosed threading pin (See P12) facilitates the process.

*Make sure to tie the line to the line stopper to prevent the line from slipping on the spool.

*Tighten the drag.

*If you have already completed winding of the backing line, skip this step and go to the next step.

2. Return the Jog Power Lever to OFF.

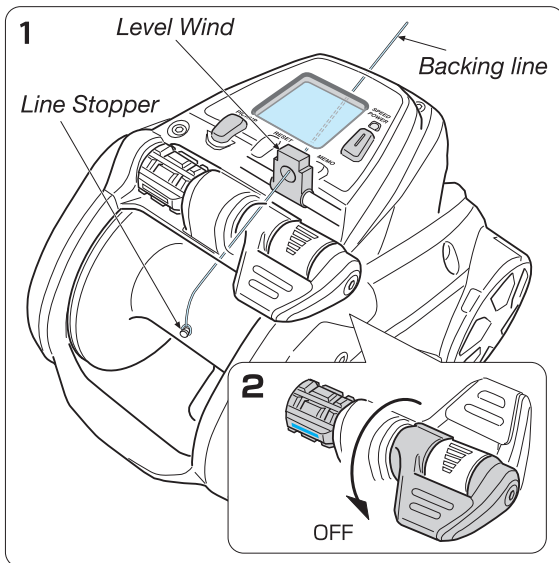

3. Turn on the reel.

*Please refer to the page 8 “How to connect Power Supply” for the details of the connection method.



↓ (The screen when the reel is switched on)

4. When **0.0** is displayed, press and hold the switches **MEMO BUTTON** and **PICKUP BUTTON** simultaneously for 2 seconds.

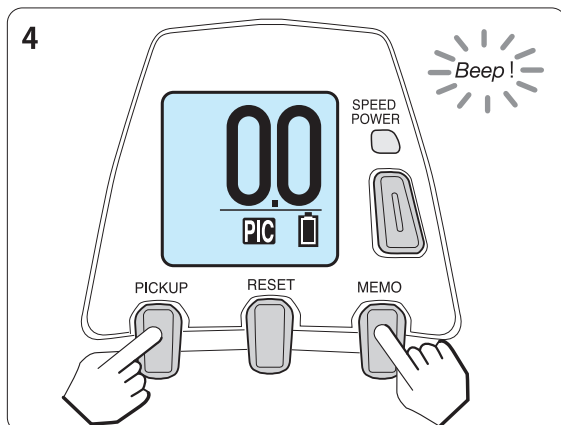

(Water Depth Screen)

Functional setting [2. Main line input]

P2 Backing line input

5. Select "Line Input" with the Jog Power Lever and press **OK** (MEMO **BUTTON**).

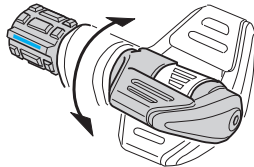

*By moving the Jog Power Lever, the selected item is highlighted on the screen.

*When the scrolling text «Do you wish to continue?» is displayed, press **OK** (MEMO **BUTTON**) one more time.

6. Select "Backing line P2" and then press **OK** (MEMO **BUTTON**).

*The screen automatically switches to "Speed Range"

7. Wind up the backing line. If winding of the backing line is completed, press **OK** (MEMO **BUTTON**).

* If you have already completed winding of the backing line, skip this step and go to the next step by pressing **OK** (MEMO **BUTTON**).

8. Firmly tie the main line to the backing line.

9. After adjusting the tension, turn the Jog Power Lever to the MAX position. and wind the main line up until the remaining line is 100 m, as checking the line color.

*While winding up the line, try to adjust the tension so that the mark ▼ stays around the screen center.

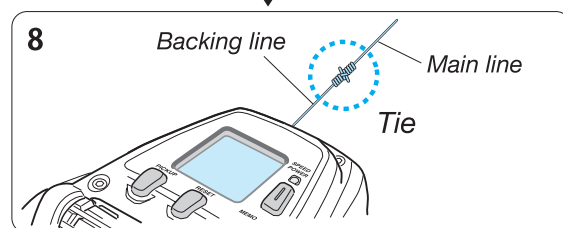
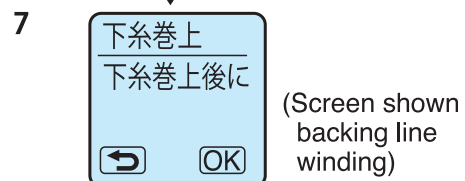
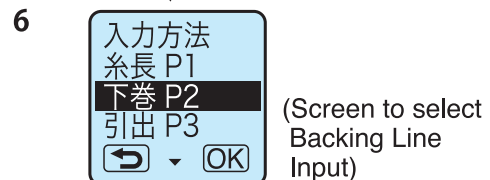
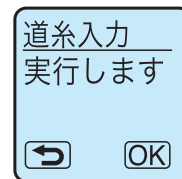
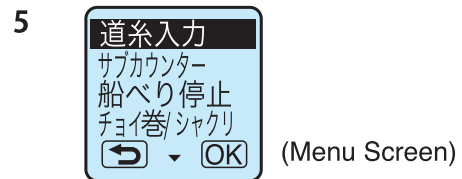
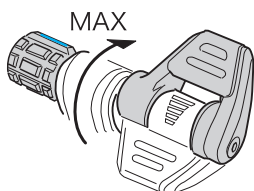

Functional setting [2. Main line input]

P2 Backing line input

Attention

-The reel may be damaged if the line touches the finger-guard or the frame. Keep the line from touching these components.
 -Winding the line indoors for a prolonged period at a low speed with an elevated tension may cause the motor to overheat and thus fail. When winding the line, turn the Power Lever to the MAX position on the Speed Range screen. When actually fishing outdoors, there is no need to worry because it is cooled with seawater, etc.

10. When winding is completed, turn the Jog Power Lever back to the OFF position and then press **OK** (MEMO **BUTTON**).

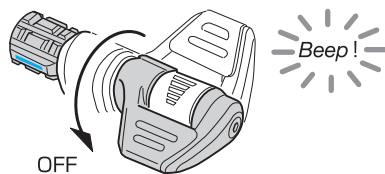

11. After adjusting the tension, turn the Jog Power Lever to the MAX position. Wind on another 50 m of line as checking the line color.

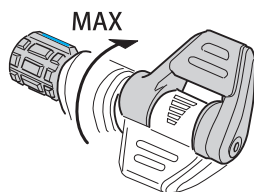

11

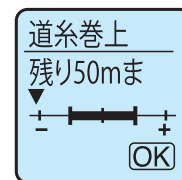

(Screen shown main line winding)

*While winding up the line, try to adjust the tension so that the mark ▼ stays around the screen center.

12. When winding is completed, turn the Jog Power Lever back to the OFF position and then press **OK** (MEMO **BUTTON**).

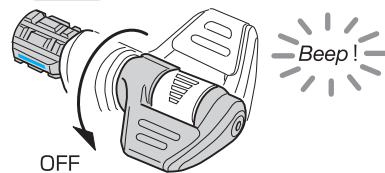

13. After adjusting the tension, turn the Jog Power Lever to the MAX position and wind the main line up to its end as checking the line color.

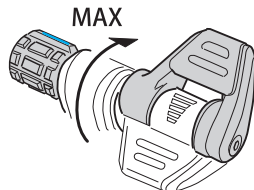

13

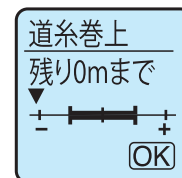

(Screen shown main line winding)

*While winding up the line, try to adjust the tension so that the mark ▼ stays around the screen center.

Functional setting [2. Main line input]

P2 Backing line input

Attention

-Do not wind all the line. Before winding up all of the line, turn the Jog Power Level to the OFF position and then wind up the remaining line manually with the handle. Winding up all may cause an error with the counter.

-This winding method cannot be applied to lines thinner than PE 20lb.

-When winding a PE 20lb line, the line may enter the gap between the spool and the frame if wound close to the spool's outer diameter; so it is advisable to wind the line up to about 1mm inside the outer edge of the spool.

14. When winding is completed, turn the Jog Power Lever back to the OFF position and then press **OK** (**MEMO BUTTON**).

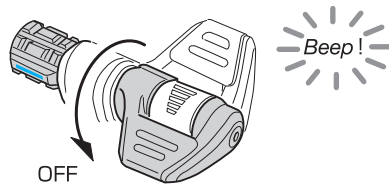

15. When “Complete” is displayed on the screen, press **OK** (**MEMO BUTTON**) to return to the Water Depth screen and complete the data input of the line.

* If “Error” appears on the screen while inputting the line data, press **OK** (**MEMO BUTTON**) to return to the Water Depth screen and re-start the process from the beginning.

15

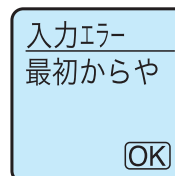
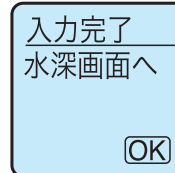

Functional setting [2. Main line input]

P3 Line re-input

This option allows you to re-enter the line data, pulling out the line after it has been completely wound up onto the reel.

Note that it is necessary that you know the line length and that it is greater than 100 m.

1. Pass the main line through the Level Wind and tie it to the spool.

*The enclosed threading pin (See P12) facilitates the process.

*Make sure to tie the line to the line stopper to prevent the line from slipping on the spool.

*Tighten the drag.

2. Return the Jog Power Lever to OFF.

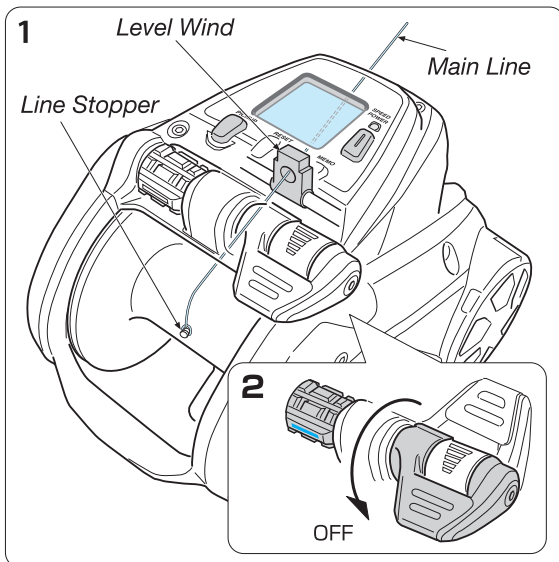

3. Turn on the reel.

*Please refer to the page 8 “How to connect Power Supply” for the details of the connection method.



↓ (The screen when the reel is switched on)

4. When **0.0** is displayed, press and hold the switches **MEMO BUTTON** and **PICKUP BUTTON** simultaneously for 2 seconds.

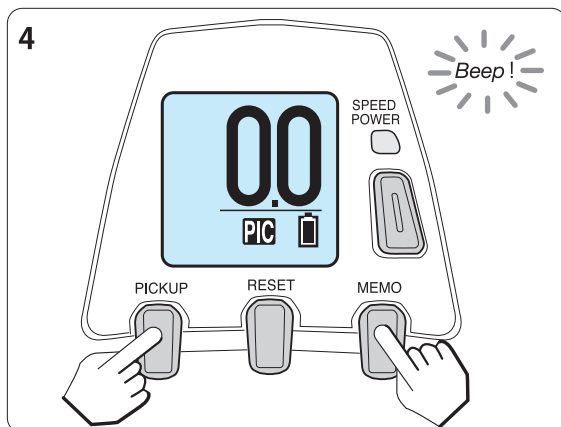

(Water Depth Screen)

Functional setting [2. Main line input]

P3 Line re-input

5. Select “Line Input” with the Jog Power Lever and press **OK** (**MEMO BUTTON**).

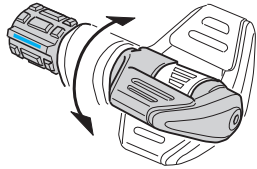

*By moving the Jog Power Lever, the selected item is highlighted on the screen.

*When the scrolling text 《Do you wish to continue?》 is displayed, press **OK** (**MEMO BUTTON**) one more time.

6. Select “Line re-input P3” and then press **OK** (**MEMO BUTTON**).

*The screen automatically switches to “Speed Range”

7. After adjusting the tension, turn the Jog Power Lever to the MAX position and then wind the main line.

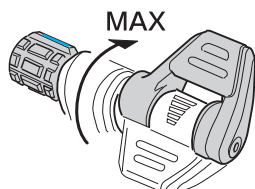

*While winding up the line, try to adjust the tension so that the mark ▼ stays around the screen center.

*When you have already completed winding the main line, simply press **OK** (**MEMO BUTTON**).

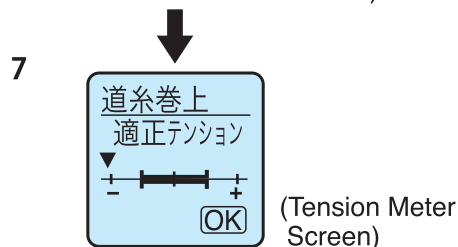
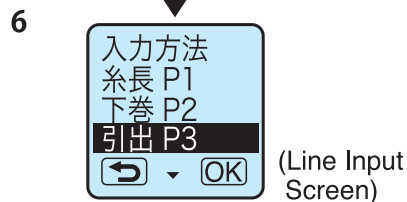
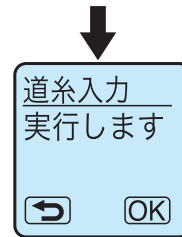

Attention

- The reel may be damaged if the line touches the finger-guard or the frame. Keep the line from touching these components.
- Winding the line indoors for a prolonged period at a low speed with an elevated tension may cause the motor to overheat and thus fail. When winding the line, turn the Power Lever to the MAX position on the Speed Range screen. When actually fishing outdoors, there is no need to worry because it is cooled with seawater, etc.

Functional setting [2. Main line input]

P3 Line re-input

8. When winding is completed, turn the Jog Power Lever back to the OFF position and then press **OK** (**MEMO** **BUTTON**).

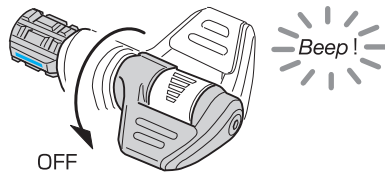

9. Pull 50 m of the line out of the reel as checking the line color and press **OK** (**MEMO** **BUTTON**).

10. Pull another 50 m of the line out of the reel as checking the line color and press **OK** (**MEMO** **BUTTON**).

11. When “Complete” is displayed on the screen, press **OK** (**MEMO** **BUTTON**) to return to the Water Depth screen. Wind up the line that you pulled out from the reel. If you wound it up, the procedure is completed.

*If “Error” appears on the screen while inputting the line data, press **OK** (**MEMO** **BUTTON**) to return to the Water Depth screen and re-start the process from the beginning.

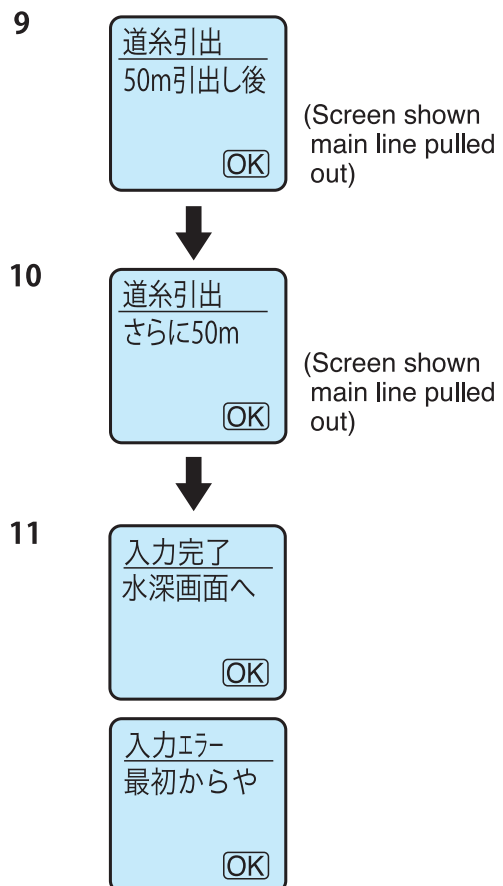

Functional setting [3. Sub counter]

Sub counter can be displayed below the Water Depth counter.
You can select one from 3 options; i.e. “Inverse counter”, “Winding speed” and “Time to wind up”

*Sub counter is set to “No display” by default.

Inverse counter

You can easily identify a shelf in the strike zone for fishing with the distances from the boat and from the bottom by two counters.

1. Press and hold both **MEMO BUTTON** and **PICKUP BUTTON** simultaneously for 2 seconds to go to the Menu screen.
2. Select the option “Sub counter” with the Jog Power Lever and press **OK** (**MEMO BUTTON**). Then, select “Inverse counter” and press **OK** (**MEMO BUTTON**).

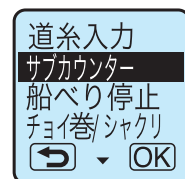
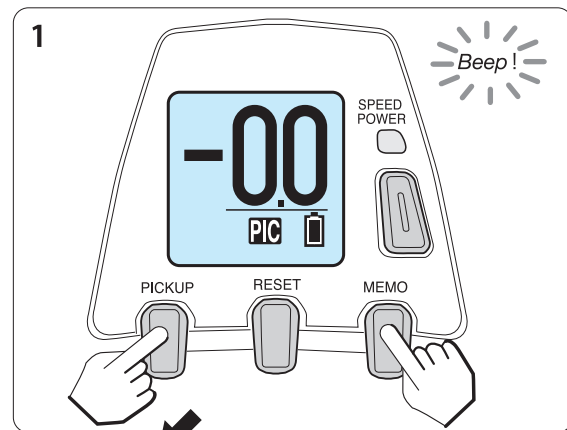
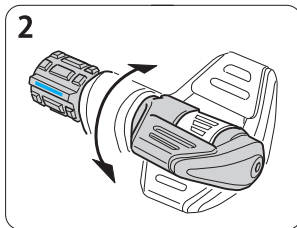

(Menu screen)

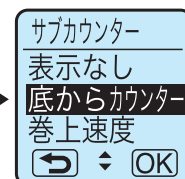

(Sub counter)

3. The Inverse counter will appear below the Water Depth counter.
4. When you press the **MEMO BUTTON** at the depth in the strike zone for fishing after lowering the terminal rig, including the bottom and your aiming shelf, the Inverse counter displays **0.0** as the reference point for showing the distance from such point.

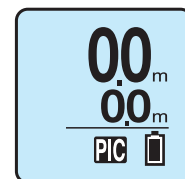

Functional setting [3. Sub counter]

Winding speed

This option displays the winding speed actually measured while the electrical winding up is in action.

1. Press and hold both **MEMO BUTTON** and **PICKUP BUTTON** simultaneously for 2 seconds to go to the Menu screen.
2. Select the option "Sub counter" with the Jog Power Lever and press **OK** (**MEMO BUTTON**). Then, select "Winding speed display" and press **OK** (**MEMO BUTTON**).

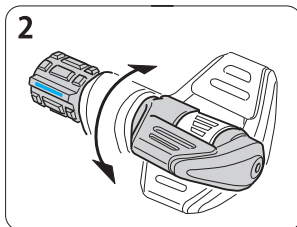

3. The winding speed will be displayed below the Water Depth counter.

*This is displayed only while electrical winding up is in action.

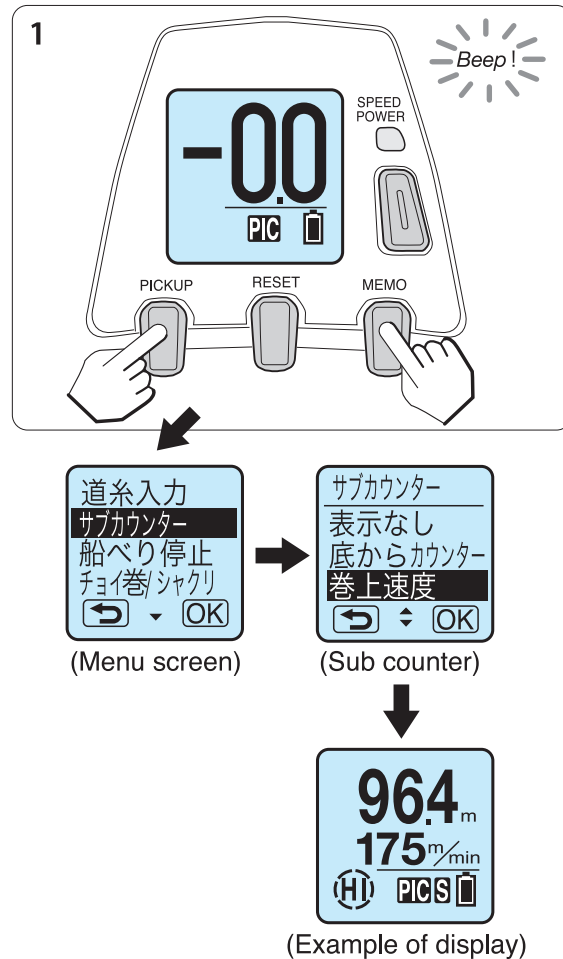

Functional setting [3. Sub counter]

Time to wind up

This option displays the timer roughly indicating the remaining time to auto stop at the boat side.

*A gap in the time may be caused by the fluctuation of the actual winding speed.

1. Press and hold both **MEMO BUTTON** and **PICKUP BUTTON** simultaneously for 2 seconds to go to the Menu screen.
2. Select the option "Sub counter" with the Jog Power Lever and press **OK** (**MEMO BUTTON**). Then, select "Time to wind up" and press **OK** (**MEMO BUTTON**).

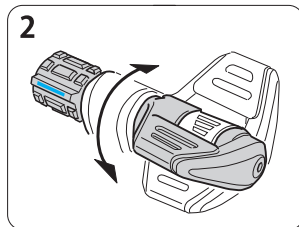

3. The time to wind up will be displayed below the Water Depth counter.

*This is displayed only while electrical winding up is in action.

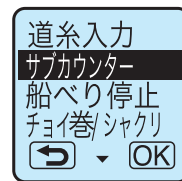
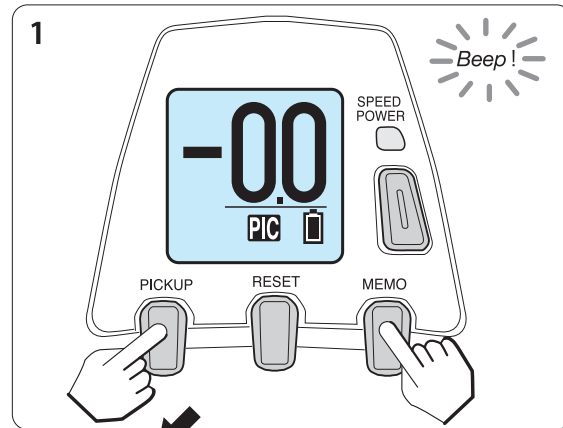

(Menu screen)



(Sub counter)

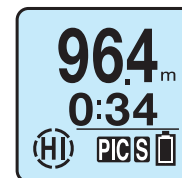

(Example of display)

Functional setting [4. Before start fishing]

Water surface zero setting

Before you start fishing, always perform this zero setting to identify a more accurate depth of the strike zone for fishing.

1. Connect the reel to the battery. Pass the line through all the guides, and prepare your terminal rig.

2. Lower the terminal rig to the water surface and press the **RESET BUTTON**.

The display resets to **0.0** and the indicator lamp **S** (auto stop) will turn on. Then the setup has been completed.

While electrical winding up is in action, winding will automatically stop at 2 m before auto stop at the boat side.

*If this "Water surface zero setting" is not made, winding will automatically stop at 5 m before the auto stop point for safety.

*After auto stop at the boat side, you can use the Jog Power Lever to wind up the line until the point where the counter indicates **0.0** m. However, after the counter indicated **0.0**, the Jog Power Lever will be disabled to use to wind up the line, to prevent the rig from being accidentally wound up due to miss operation.

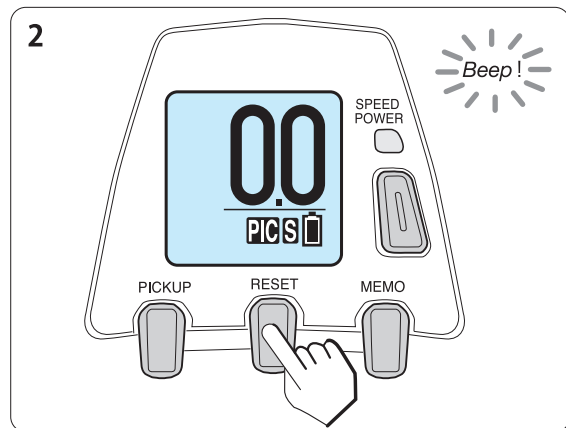
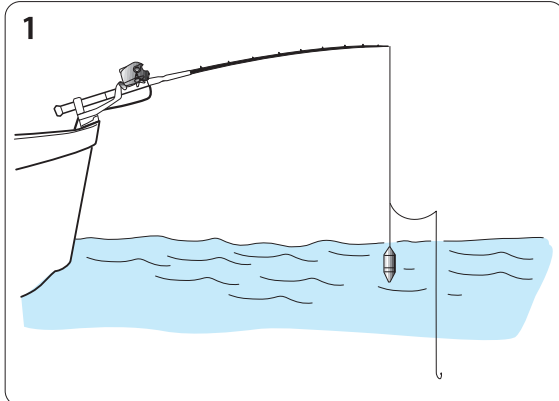

Attention

-When new line is wound up, or when line has been pulled under heavy tension, line stretch may cause a gap in the auto stop point at the boat side. Simply reset the surface setting to set it to zero.

-Depending upon the rolling of the boat or sinker weight, auto stop point can overrun slightly. Should this happen, increase the depth of the auto stop.

-Fishing at a depth over 100 m with a load largely fluctuating may cause a gap in the stop point. Thus, the terminal rig may be accidentally wound up and the rod may be broken. In such fishing, it is recommended to have sufficient margin in setting of auto stop point to avoid such events.

If the main line is broken

-Should your line break, revise data as follows.

Revise the data of the broken line. Wind the line to the rod tip while the reel is powered on. Then, press the **RESET BUTTON** for 2 seconds or more. When the display shows **0.0**, then your re-adjustment is completed.

*The line data will be overwritten (revised) by the procedure described above.

*Do not press and hold the **RESET BUTTON**, except for data correction of a broken line; it may cause an error in the counter.

Functional setting [5. Auto stop]

Adjustable auto stop setting

The auto stop point can be set to meet your own specific needs and ease your preparatory works such as checking and changing of baits and sinkers.

-You can set the auto stop point by setting the adjustable depth within the range 1 to 5 m from the point where you press **RESET BUTTON** (in 10 cm increments).

Especially in case of chumming, it is recommended to set the adjustable auto stop point so that a chumming bait sinker comes to your hand side when you raise your rod tip, for more convenient checking and changing of baits and sinkers.

Note that it is designed not to allow you to set the auto stop point to any value below 1 m for safety reasons.

-In the case when you feel the auto stop point comes down due to line stretch, simply reset the counter to zero at the water surface.

-Note that the Jog Power Lever may not be allowed to manipulate around the auto stop point for safety reasons.

There are two different ways to set the adjustable auto stop; setting in the Menu screen and setting in the Water Depth screen.

● Setting in the Menu screen

1. Press and hold both **MEMO BUTTON** and **PICKUP BUTTON** simultaneously for 2 seconds to go to the Menu screen.
2. Select "Auto Stop" with the Jog Power Lever and press **OK** (**MEMO BUTTON**).

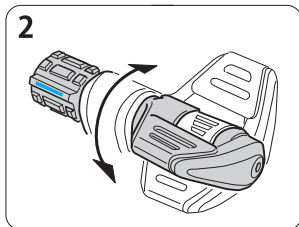

3. Then, select your desired auto stop point with the Jog Power Lever and press **OK** (**MEMO BUTTON**) to return to the Water Depth screen.

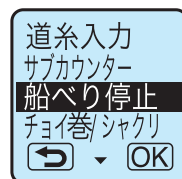
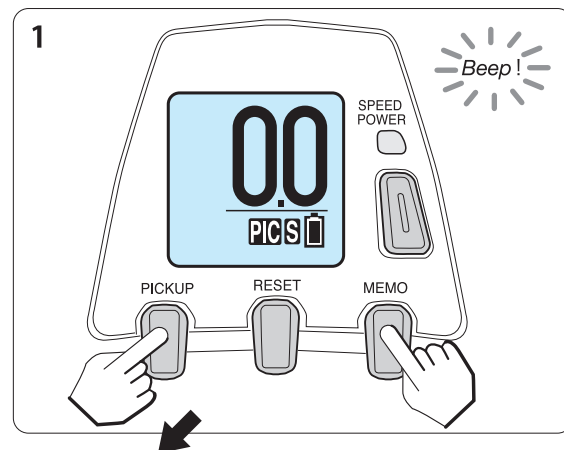
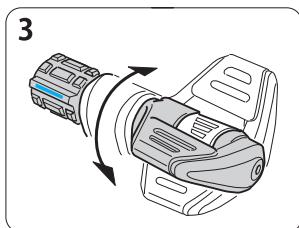

(Menu screen)

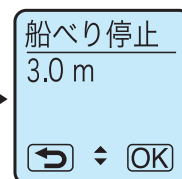

(Example of display)

*You are not allowed to set the adjustable auto stop if you have not yet set the water surface zero setting. Be sure to carry out the water surface zero setting.

4. If you carry out electrical winding up after lowering the terminal rig, your terminal rig will automatically stop at the pre-set point.

Functional setting [5. Auto stop]

● Setting in the Water Depth screen

1. While the reel is powered on and your terminal rig is on the water surface, press the **RESET BUTTON** (water surface zero setting).

The display will show **0.0** .

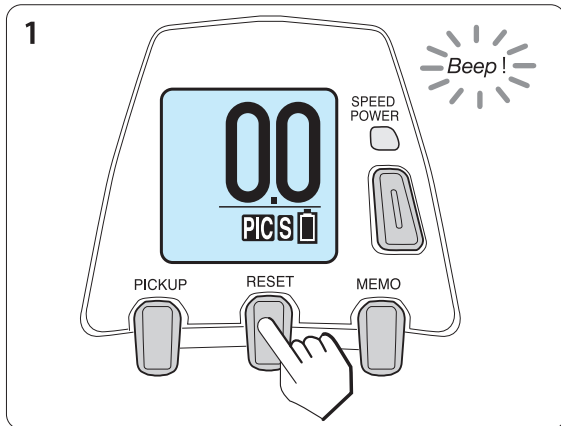

2. Raise your rod tip and pull the line out adjusting the line length from the rod tip so that you can reach the rig easily.

In the figure, its length is 1.5 m.

Use

Chumming

It is recommended to set the auto stop so that a chumming bait sinker comes to your hand side when you raise your rod tip, for more convenience for checking and changing of baits and sinkers.

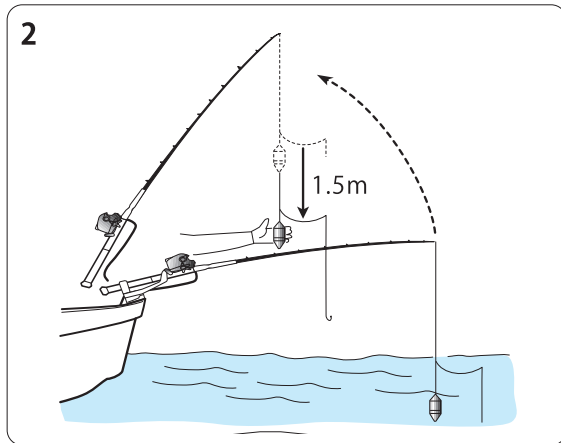

3. When the line length has been properly adjusted, press and hold the **MEMO BUTTON** for about 2 seconds.

When the indicator lamp **S** (auto stop at boat) blinks, the setting is completed.

*Auto stop is set to 2.0 m by default.

(If **RESET BUTTON** is not pressed, the reel stops at 5.0 m)

*If the setting is completed, the indicator lamp **S** (auto stop at boat) will blink.

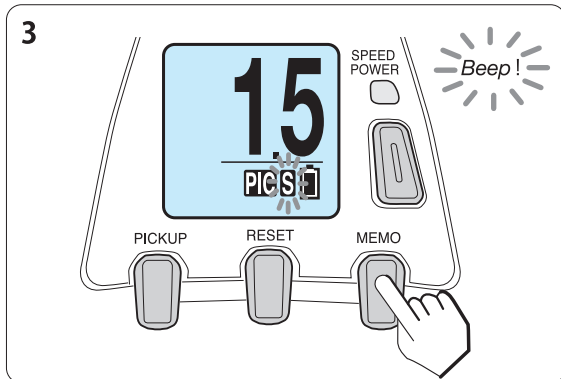

4. The electrical winding up automatically stops at the pre-set point. So, raise the rod tip to bring your terminal rig to your hand side.

Functional setting [6. Pickup / Pause]

Pickup

This is very useful. You can wind the line by the electric reel only while pressing the **PICKUP BUTTON**. The pickup speed is set to 15 by default. You can change it in the Menu screen.

Pause

This is very useful. You can pause the electrical winding up only while pressing the **PICKUP BUTTON**. When you release the button, the reel restarts winding up at the speed specified by using the Jog Power Lever.

Pickup / Pause setting

1. Press and hold both **MEMO BUTTON** and **PICKUP BUTTON** simultaneously for 2 seconds to go to the Menu screen.
2. Select "Pickup/Jigging" with the Jog Power Lever and press **OK** (**MEMO BUTTON**). Then, select "Pickup" from the Pickup/Jigging options and press **OK** (**MEMO BUTTON**).

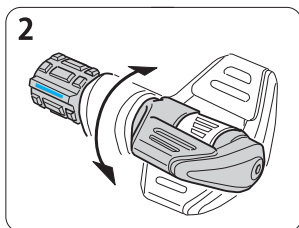

3. Set the speed with the Jog Power Lever.

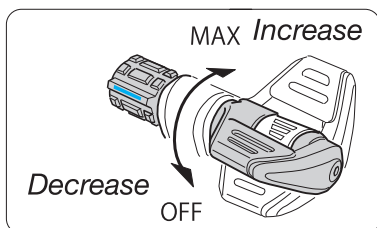

You can set the speed to any value in the range from 0 to Hi (in the figure, the speed is set to 20). Set it to 1 to Hi to make the reel in the Pickup mode or otherwise set it to 0 to make the reel in the Pause mode.

4. Press **OK** (**MEMO BUTTON**) to return to the Water Depth screen. Now, the setting is completed.

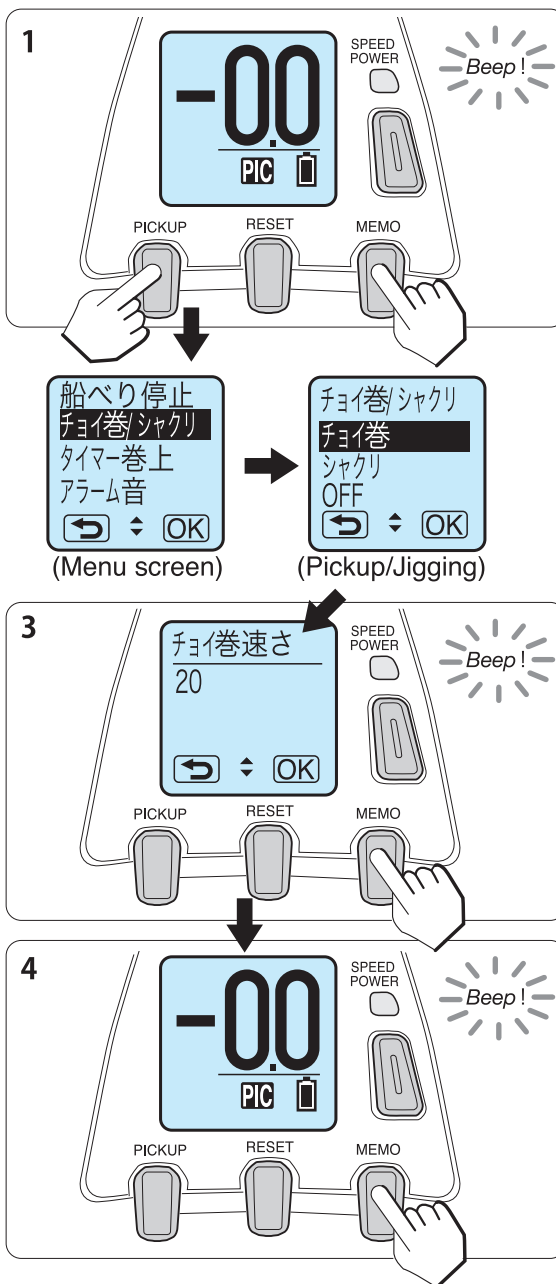

Functional setting [7. Jigging]

Jigging

This function is useful to let the reel control the line so as to slack and jig the line to attract fish. Once you have set up this function, the reel starts jigging when you press the PICKUP **BUTTON**. You can adjust the jigging speed by using the Jog Power Lever.

1. Press and hold both **MEMO BUTTON** and **PICKUP BUTTON** simultaneously for 2 seconds to go to the Menu screen.

2. Select "Pickup/Jigging" with the Jog Power Lever and press **OK** (**MEMO BUTTON**). Then, select "Jigging" and press **OK** (**MEMO BUTTON**).

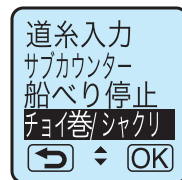
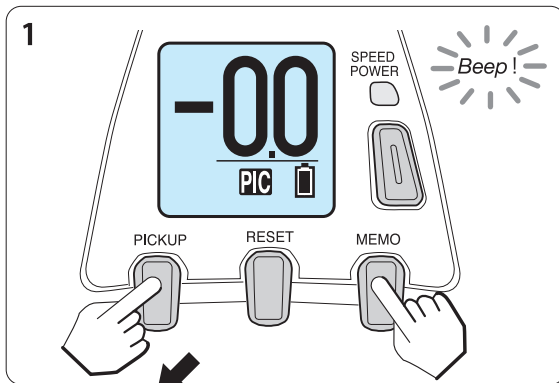
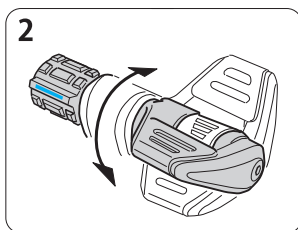

(Menu Screen)

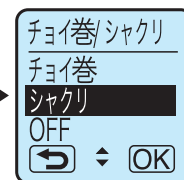

(Pickup/Jigging)

3. Select any pattern from the Jigging Pattern options with the Jog Power Lever and press **OK** (**MEMO BUTTON**).

You can select the number of steps per a length of the line wound up in a single cycle of jigging.

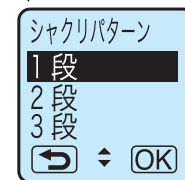
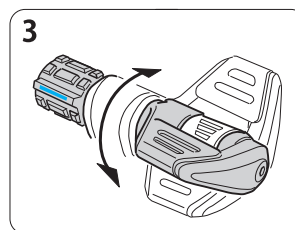

(Jigging Patterns)

One-step jigging	Two-step jigging	Three-step jigging	Random jigging
			<p>Random jigging is the method in which the number of jigging steps from 1 to 3 is randomly and automatically selected by the IC system to attract fish. It is a marvelous auto jigging mechanism.</p>

A : 4 seconds stop B : 0.4 seconds stop

*In the figure, a rod is used to represent the jigging but actually the line is jigged and wound up by the reel.

Functional setting [7. Jigging]

4. Set the Jigging length with the Jog Power Lever and press **OK** (**MEMO BUTTON**) .

You can select the length of the line wound up in a single cycle of jigging (the length may slightly overrun its preset length depending on the sinker or winding speed).

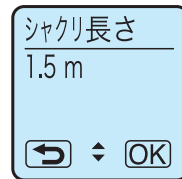
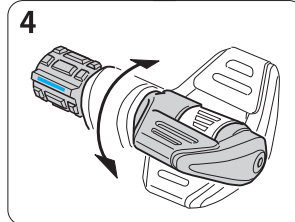

(Example of display)



5. Set the interval time with the Jog Power Lever and press **OK** (**MEMO BUTTON**) .

You can select the interval time (waiting time) between jigging cycles.

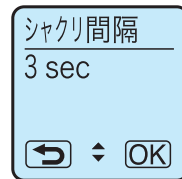
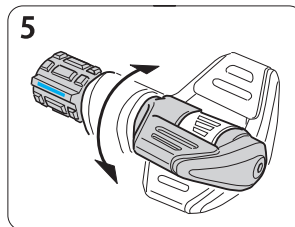

(Example of display)

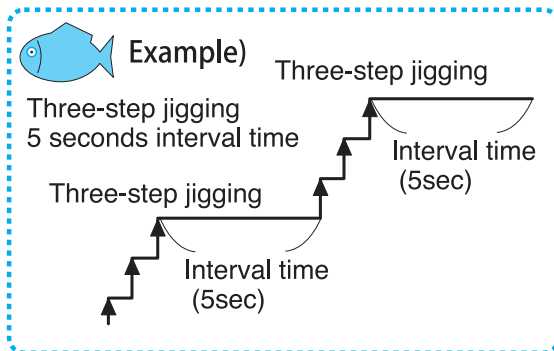

Attention

If the time preset to "chumming timer winding time" is shorter than the jigging time (in seconds), then the chumming timer setting takes priority to wind up the line.

6. Set the jigging range with the Jog Power Lever and press **OK** (**MEMO BUTTON**) to return to the Water Depth screen. Now, the setting is completed.

You can select the range of jigging.

*If you have set the range to OFF, jigging will be continuously performed to the auto stop point.

*If you have set the range to any value, jigging will be performed only for the specified range.

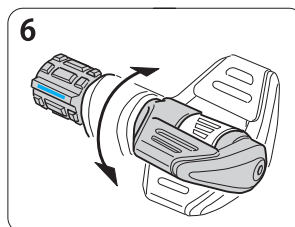

(Example of display)

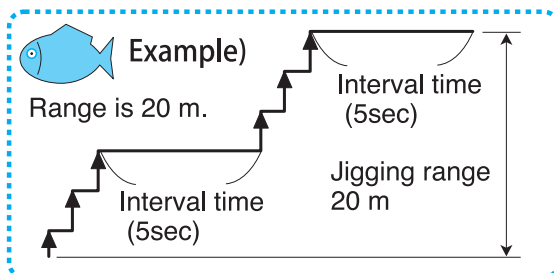

Functional setting [7. Jigging]

7. After lowering the terminal rig, press the **PICKUP BUTTON** and set the jigging speed with the Jog Power Lever. Then, the reel will start jigging.
- The indicator **JIG** (Jigging) is blinking while the line is being wound up in the jigging mode.
 - You can adjust the jigging speed with the Jog Power Lever.
 - If you press the **PICKUP BUTTON** while jigging is in process, jigging will stop.

Functional setting [8. Chumming Timer]

Chumming Timer

The display shows precisely the time having elapsed every since the rig was dropped. It is very helpful to determine the pace for checking and changing of baits and sinkers.

- The display shows the time having elapsed since lowering of the rig started. You can roughly estimate the timing to chum or collect the rig.
- If you have not pressed the **MEMO BUTTON**, the chumming timer automatically starts when the depth counter determined the depth 7.0 m.

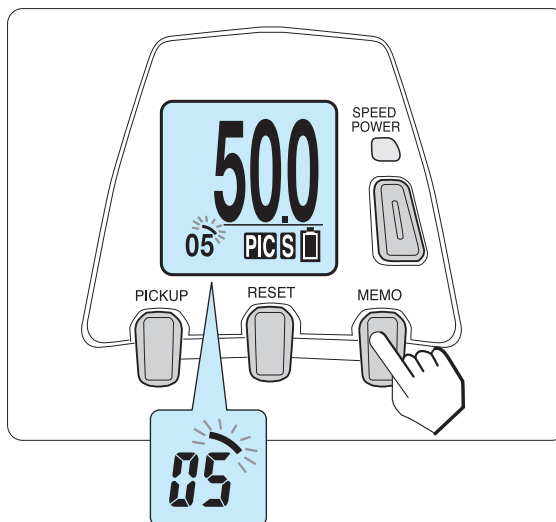

- *The time is indicated in seconds if the remaining time is less than 60 seconds. It is indicated in minutes if the remaining time is not less than 1 minute.
- *The timer function may not be reset.

Attention

If you press the **MEMO BUTTON** while chumming is in process, the timer indication will start from **0**.

Functional setting [9. Chumming Timer winding]

Chumming Timer Winding

Professional fishing techniques of checking and changing of baits and sinkers for all levels including beginners! Once you have set the waiting time simply, the reel automatically starts winding up. You can enjoy fishing more effectively and easily.

-If you have set the waiting time for a single chumming to 5 minutes, the reel will automatically start winding up at a high speed to allow you to check and change baits and sinkers after preset 5 minutes have passed.

1. Press and hold both **MEMO BUTTON** and **PICKUP BUTTON** simultaneously for 2 seconds to go to the Menu screen.
2. Select the "Timer Winding" with the Jog Power Lever and press **OK** (**MEMO BUTTON**) .

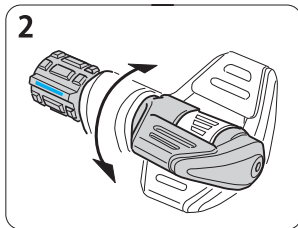

3. Select the waiting time (in minute) for checking and changing of baits and sinkers with the Jog Power Lever.

Turn the Jog Power Lever upward to increase the value. Or, turn it downward to decrease the value. (In the figure, the waiting time is set to 5 minutes)

4. Press **OK** (**MEMO BUTTON**) . If the screen returns to the "Water Depth screen", then the setting is completed.

The indicator **T** (Timer) will light up on the screen.

5. The reel will automatically starts winding up the rig at its maximum speed when the preset time has elapsed while the clutch is powered on after lowering the terminal rig.

- An audible alarm will sound before the reel starts winding.
- If the clutch is powered OFF, the reel will not start automatic winding up.
- The chumming timer automatically starts when the depth counter determined the depth 7.0 m. But, you can reset the timer once and restart it by pressing **MEMO BUTTON** .

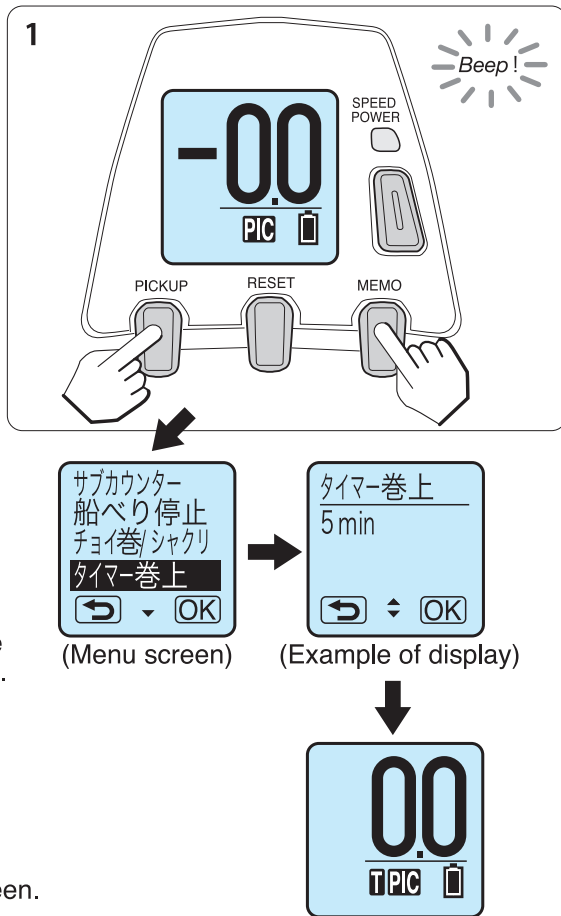

Functional setting [10. Water depth recalibration]

Water depth recalibration

You can recalibrate the counter if it does not match the depth identified by the color markings on your line.

Use

You can recalibrate the counter while you are fishing!

(Example) To recalibrate the counter to 100 m to comply with the depth identified as just 100 m by the color of the line, though the counter shows 103 m.

1. When the water depth to be corrected is displayed, press and hold both **MEMO BUTTON** and **PICKUP BUTTON** simultaneously for 2 seconds to go to the Menu screen.
2. Select the "Water depth recalibration" with the Jog Power Lever and press **OK** (**MEMO BUTTON**).

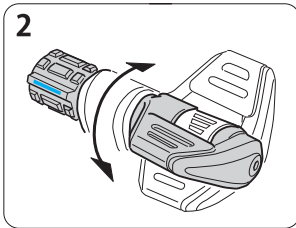

- *The scrolling text «Do you wish to continue?» is displayed. If you confirm the choice, press **OK** (**MEMO BUTTON**) again.
- *Any correction cannot be made if the water depth is less than 10.0 m.

3. Select your desired water depth with the Jog Power Lever and press **OK** (**MEMO BUTTON**) to return to the Water Depth screen.

4. Now, the water depth has been corrected.

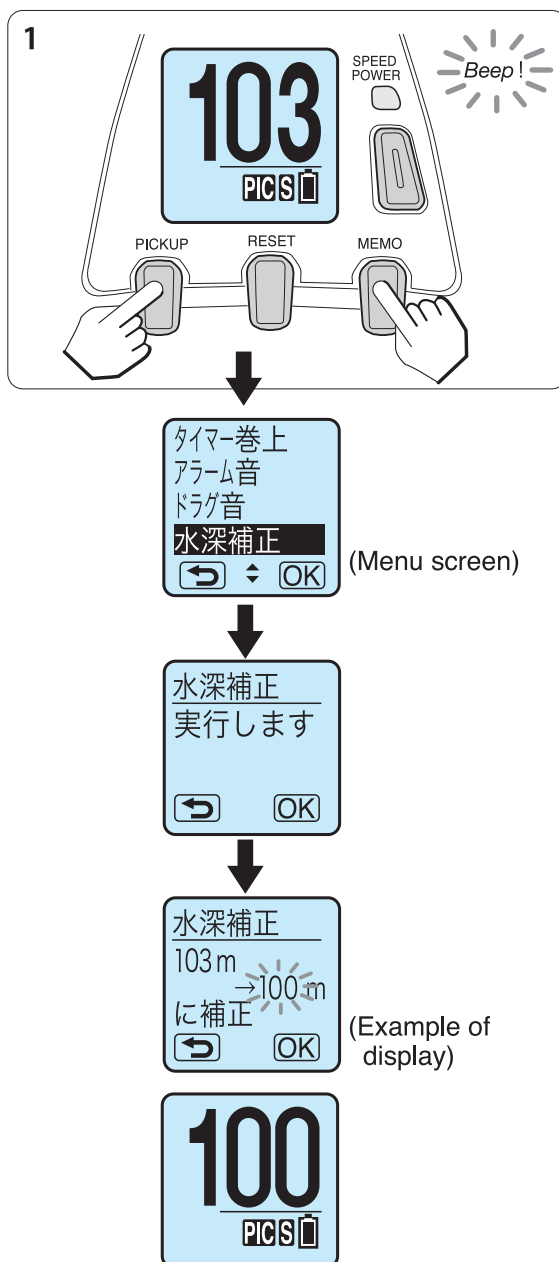

Functional setting [11. Actual fishing history]

Actual fishing history

You can check the total winding distance and the total hours of fishing using the electric reel.

1. Press and hold both **MEMO BUTTON** and **PICKUP BUTTON** simultaneously for 2 seconds to go to the Menu screen.
2. Select the “Actual fishing history” with the Jog Power Lever and press **OK** (**MEMO BUTTON**).

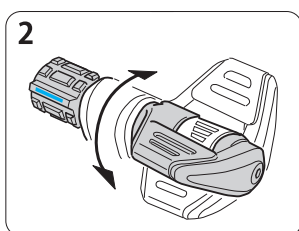

3. You can check the total winding distance and the total hours of fishing using the electric reel. Press **OK** (**MEMO BUTTON**) to return to the Water Depth screen.

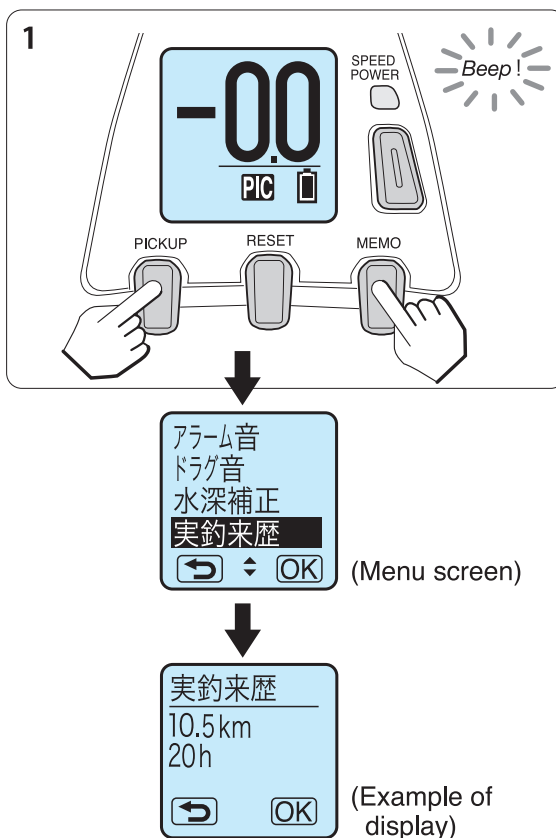

Functional setting [12. How to fix the rod with clamp]

For mounting a rod onto a metallic bat or for your fishing with a heavy load on the rod charge, always fix the rod with clamp.

*A rod bat 18 to 34 mm in diameter is allowed to be fixed with the rod clamp.

1. Insert the bolts onto the clamp setting holes on the frame and fix it using washers and nuts.

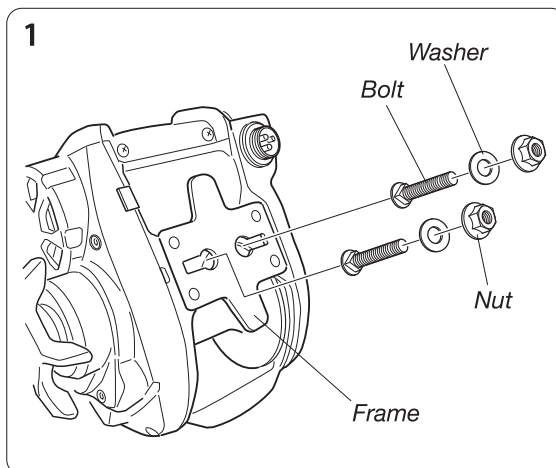

2. Set the reel on your rod. Put the clamp plate on the rod so as to clamp the rod. Fix them with the clamp plate nuts (S) or (L) according to the bat diameter.

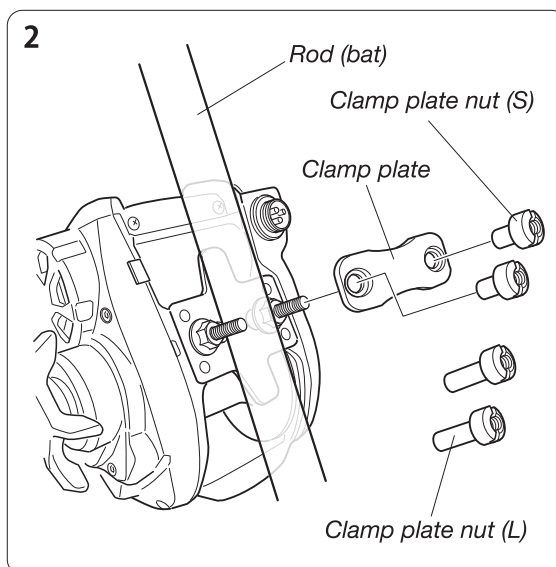

Attention

-If the nuts are tightened too tightly, there is a risk of deformation in the reel seat portion on the rod if the reel seat material is resin.

-Do not use the reel with bolts only fixed without any other parts fixed. It may cause a risk of injury on your fingers cut by the threading of the bolts.

Functional setting [13. How to remove the handle knob]

1. Holding the handle knob with your hand, loosen the handle knob cap by turning it counter-clockwise to loosen using a coin and remove it.

*Be sure to fit a coin properly onto the groove on the handle knob cap before turning it. Otherwise, the handle knob cap will be damaged while turning it.

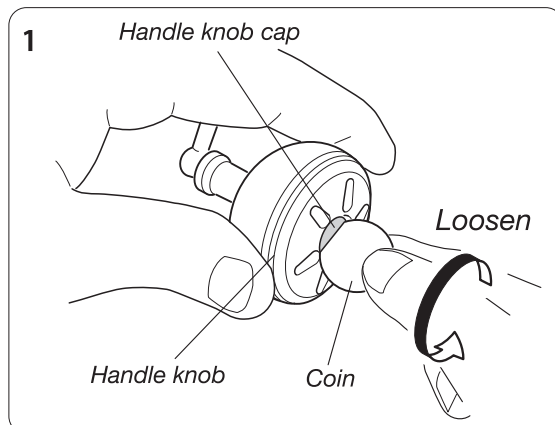

2. Loosen and remove the screw fixed inside of the knob using a screw driver.

*Note that the screw is coated with a slack preventing agent and it is hardly loosened. Be careful not to damage the screw head.

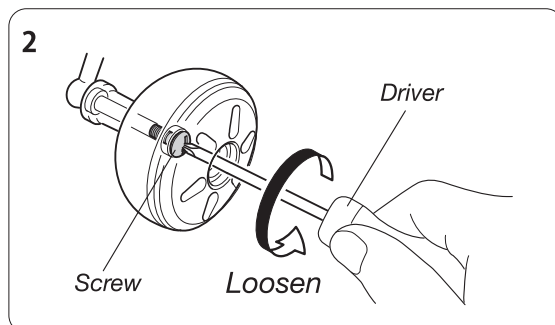

3. The handle knob is composed of as shown in the figure.

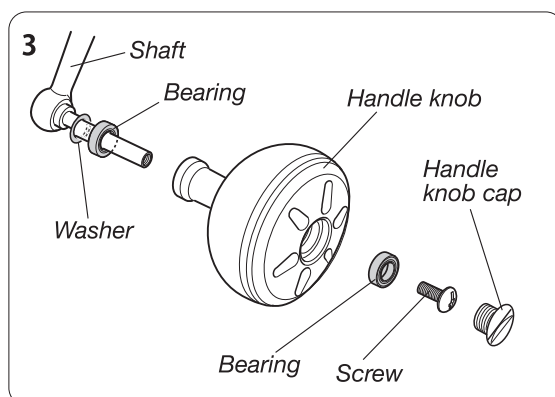

Functional setting [14. Other useful functions]

Various alarms

Many kinds of information are indicated by audible alarms such as auto stop alarm and range memory alarm.



Jog Power Lever alarm

-When you place the Jog Power Lever at MAX or OFF position, an alarm beeps to tell you its position.

Auto stop alarm

-While winding up, an alarm shortly beeps starting 6 m below the auto stop point, at two meter intervals, to tell you that the rig is coming closer to the auto stop point. When it reached the auto stop point, an alarm sounds for longer.

Range memory alarm

-While lowering your rig back into the strike zone, an alarm shortly beeps starting 6 m above the memorized depth range of the strike zone, at 2 m intervals, to tell you that the rig is reaching closer to the strike zone. When the rig reached the strike zone, an alarm sounds for longer.

*This zone memory alarm is designed not to sound unless the line has been wound more than 6 m above the memorized depth and the line is fed again for the purpose of preventing the alarm from frequently sounding while seeking the strike zone.

Switch alarm

-Each time a button is pressed, a beep is sounded to allow you to confirm that you have surely pressed a button (You can set this alarm to OFF in the setting of functions from the Menu screen).

Excessive voltage alarm

-If you connected a power source with a voltage higher than the acceptable range, a continuous alarm will sound to warn you to stop operation. DO NOT operate the reel with such battery.

Timer winding alarm

-This alarm sounds to tell you before starting a chumming timer winding.

Alarm sound ON/OFF setting

You can set the alarm sound to OFF.

-It is set to ON by default.

-Once the alarm sound has been set to OFF, the alarm will no longer sound even if you have pressed buttons or have used the power lever for operation.

1. Select "Alarm sound" in the Menu screen.
2. Select OFF with the Jog Power Lever.
3. Press **OK** (MEMO BUTTON). If the screen returns to the "Water Depth screen", then the setting is completed.

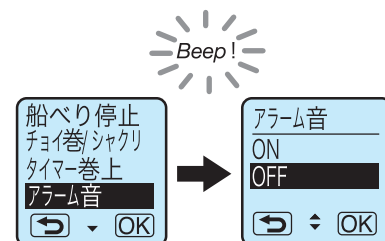

Functional setting [14. Other useful functions]

Drag sound ON/OFF setting

You can set the drag sound to OFF.



- It is set to ON by default.
 - Once the drag sound has been set to OFF, the electronic beep will no longer sound even if the drag is pulled out.
1. Select "Drag sound" in the Menu screen.
 2. Set the drag sound to OFF with the Jog Power Lever.
 3. Press **OK** (MEMO **BUTTON**). If the screen returns to the "Water Depth screen, the setting is completed.

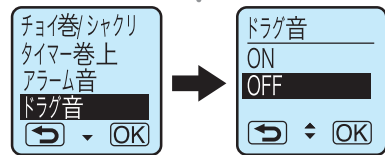

Language setting

You can select Japanese or English for a language to be displayed on the LCD screen.

1. Select "Language" in the Menu screen.
2. Select your desired language with the Jog Power Lever.
3. Press **OK** (MEMO **BUTTON**). If the screen returns to the "Water Depth screen", then the setting is completed.

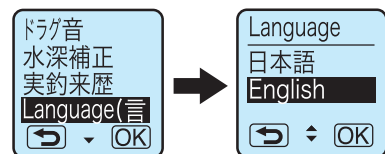

Unit setting

You can select "m" (meter) or "ft" (feet) for a unit to be used for the length.

*Note that the unit is represented in "m" (in meters) only when entering a value in "Main line input" even if "ft" (in feet) has been set for the unit.

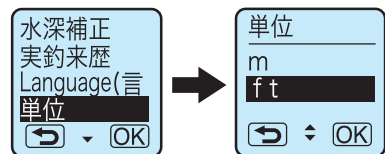

Counter lamp

The lamp built in the counter always lights up.

- While the reel is powered ON, backlighting of the display always provides easier reading for fishing in the dark.

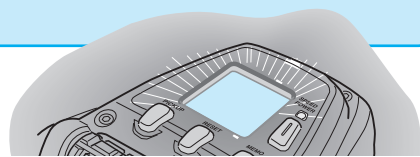

Circuit breaker display

The lamp built in the counter always lights up.

- For safety fishing, the circuit breaker is tripped by an overload onto the reel to stop electrical winding for 15 seconds. While the circuit breaker is tripped, it is displayed as shown in the figure.

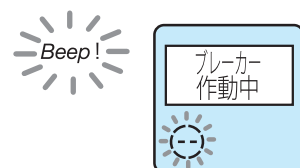

(Indicator is blinking)

Reel Specifications

Reel Specification list

SEABORG800MJ

Product name		00801466	
Gear ratio(manual winding)		2.9:1	
Weight (g)		1,770	
Max Drag power (kg)		33	
Line Capacity (m) **Bright** refers to our product "Tana Sensor Bright (PE)".	Bright (model-m)	6	800
		8	600
		10	500
		12	400
	Nylon (lb-m)	12	500
		14	400
		16	350
Number of ball bearings		22	
Power-supply voltage		DC12V~16.8V	
Maximum winding power *1 (Kg)		622	
Normal winding speed (with 1kg load) *2(m/min)		Hi: 140 / Lo:60	
AFS standard winding power *3(Kg)		48	
JAFS standard winding speed *3(m/min)		Hi: 170 / Lo: 70	
Current (A)	No load	4	
	Stall	Hi:7 / Lo:5	
	Max	20	
Speed shifting	No load	0 – 170 m / min (continuous shifting)	
Compatible battery		DAIWA Super Lithium Series DAIWA Tough Battery Series	

*1:Maximum winding power: Reference value of shaft torque at supply voltage 13V (Kg=Kgf- cm)

*2:Normal winding speed: Average winding speed of 100 m line with 1kg load at supply voltage 13V

*3:JAFS standard winding speed / winding speed = Regulation of JFTMA (Japan Fishing Tackle Manufacturer's Association), actual measurement value at supply voltage 13V

Counter display

Depth display range	Upper counter: 0.0 to 3,000 m Lower counter: - 3,000 m to 3,000 m
Usable temp. range	-10 to +60 (degrees centigrade)

*The specifications are subject to change without prior notice for product improvement.

Parts List

SEABORG 1200MJ

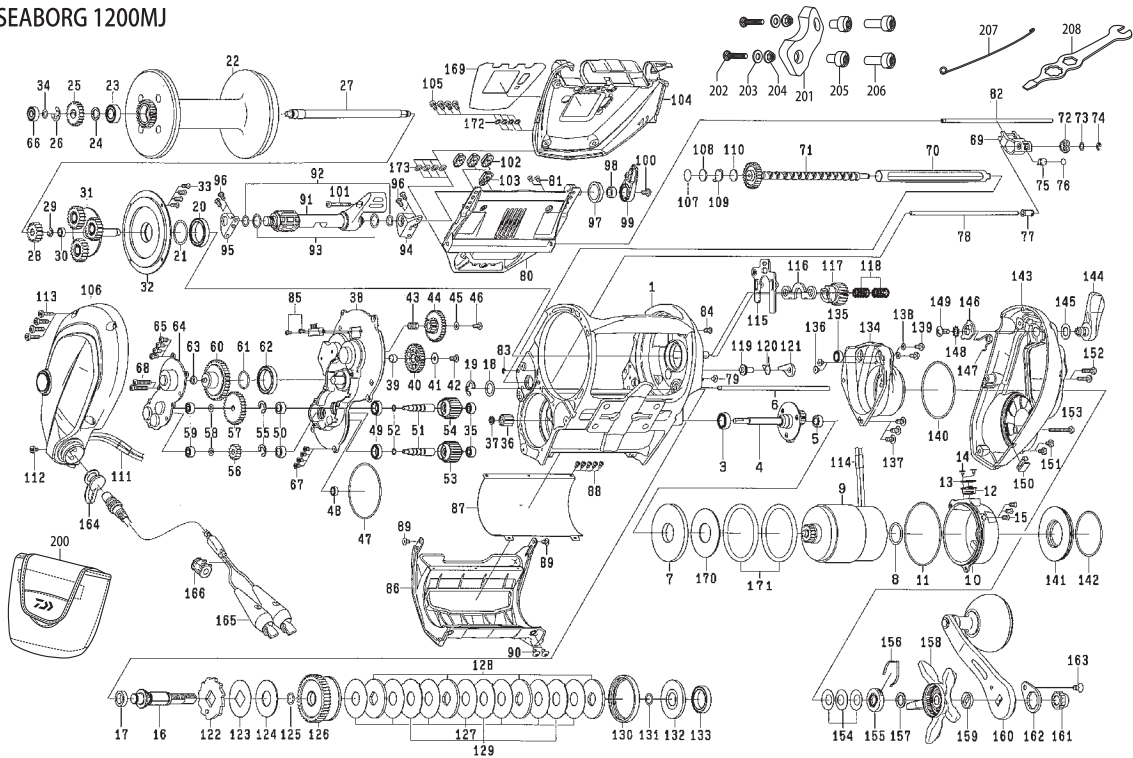

SEABORG 1200MJ

No.	Parts Name	No.	Parts Name	No.	Parts Name	No.	Parts Name
1	FRAME	47	SET PLATE O RING	92	JOG POWER LEVER O RING	137	R/S COVER SCREW (A)
3	MOTOR GEAR (B) BALL BEARING	48	SET PLATE BALL BEARING	93	JOG POWER LEVER WASHER	138	R/S COVER SCREW (B) WASHER
4	MOTOR GEAR (A)	49	MOTOR GEAR SHAFT BALL BEARING	94	JOG POWER LEVER HOLDER (R)	139	R/S COVER SCREW (B)
5	MOTOR GEAR (A) BALL BEARING	50	SET PLATE GEAR BALL BEARING	95	JOG POWER LEVER HOLDER (L)	140	R/S COVER O RING
6	LINE GUARD POST	51	MOTOR GEAR SHAFT	96	JOG POWER LEVER HOLDER SCREW	141	MOTOR HOLDER PLATE
7	MOTOR PLATE	52	MOTOR GEAR SHAFT O RING	97	JOG POWER LEVER RING	142	MOTOR HOLDER PLATE O RING
8	MOTOR O RING (A)	53	MOTOR GEAR (HIGH)	98	JOG POWER LEVER COLLAR	143	R/S PLATE
9	MOTOR	54	MOTOR GEAR (LOW)	99	JOG POWER LEVER (B)	144	CLUTCH LEVER
10	MOTOR HOLDER	55	MOTOR GEAR SHAFT RETAINER	100	JOG POWER LEVER (B) SCREW	145	CLUTCH LEVER WASHER
11	MOTOR HOLDER O RING	56	IDLE GEAR (C)	101	JOG POWER LEVER SCREW	146	CLUTCH CAM
12	MOTOR HOLDER PACKING	57	IDLE GEAR (D)	102	PUSH BUTTON	147	CLUTCH CAM SPRING
13	MOTOR HOLDER PACKING WASHER	58	IDLE GEAR WASHER	103	SHIFT SWITCH BUTTON	148	CLUTCH CAM WASHER
14	MOTOR HOLDER PACKING SCREW	59	IDLE GEAR BALL BEARING	104	IC MODULE COVER	149	CLUTCH CAM SCREW
15	MOTOR HOLDER SCREW	60	IDLE GEAR (E)	105	IC MODULE COVER SCREW	150	LINE PTOPPER
16	GEAR SHAFT	61	IDLE GEAR (E) O RING	106	L/S PLATE	151	R/S PLATE SCREW (A)
17	GEAR SHAFT COLLAR	62	IDLE GEAR (E) BALL BEARING	107	MECHANICAL BRAKE KNOB WASHER (A)	152	R/S PLATE SCREW (B)
18	GEAR SHAFT WASHER	63	IDLE GEAR (E) COLLAR	108	MECHANICAL BRAKE KNOB WASHER (B)	153	R/S PLATE SCREW (C)
19	GEAR SHAFT RETAINER	64	SET PLATE (B)	109	MECHANICAL BRAKE KNOB WASHER (C)	154	DRAG SPRING WASHER
20	SPOOL PLATE BALL BEARING	65	SET PLATE (B) SCREW	110	MECHANICAL BRAKE KNOB WASHER (D)	155	DRAG HOLDER
21	SPOOL PLATE WASHER	66	SPOOL SHAFT BALL BEARING (B)	111	CODE COVER	156	DRAG HOLDER LEAF SPRING
22	SPOOL	67	SET PLATE SCREW (A)	112	L/S PLATE SCREW (A)	157	HANDLE WASHER
23	SPOOL SHAFT BALL BEARING (A)	68	SET PLATE SCREW (B)	113	L/S PLATE SCREW (B)	158	STAR DRAG
24	SPOOL SHAFT GEAR WASHER	69	LEVELWIND	114	CODE COVER	159	HANDLE COLLAR
25	SPOOL SHAFT GEAR (B)	70	WORM SHIELD	115	SLIDE PLATE	160	HANDLE
26	SPOOL SHAFT GEAR RETAINER	71	WORM SHAFT	116	CLUTCH PLATE	161	HANDLE NUT
27	SPOOL SHAFT	72	WORM SHAFT COLLAR	117	PINION	162	HANDLE LOCK PLATE
28	SPOOL SHAFT GEAR (A)	73	WORM SHAFT WASHER	118	CLUTCH PLATE SPRING	163	HANDLE LOCK PLATE SCREW
29	SPOOL SHAFT GEAR (A) RETAINER	74	WORM SHAFT RETAINER	119	STOPPER PIN	164	CONNECTOR CAP
30	SPOOL GEAR BALL BEARING	75	PAWL	120	STOPPER SPRING	165	CODE
31	SPOOL GEAR	76	PAWL WASHER	121	STOPPER	166	FERRITE CORE
32	SPOOL PLATE	77	LEVELWIND POST COLLAR	122	RATCHET	169	IC MODULE COVER PLATE
33	SPOOL PLATE SCREW	78	LEVELWIND POST	123	RATCHET WASHER	170	MOTOR WASHER
34	SPOOL SHAFT WASHER	79	LEVELWIND POST SCREW	124	DRIVE GEAR WASHER	171	MOTOR O RING (B)
35	MOTOR GEAR BALL BEARING	80	IC MODULE	125	GEAR SHAFT O RING	172	IC MODULE COVER WASHER (A)
36	MOTOR GEAR (B)	81	IC MODULE SCREW	126	DRIVE GEAR	173	IC MODULE COVER WASHER (B)
37	MOTOR GEAR (B) WASHER	82	IC MODULE POST	127	DRAG WASHER	200	REEL CASE
38	SET PLATE (A)	83	IC MODULE POST RETAINER	128	DRAG DISC WASHER	201	CRAMP PLATE
39	IDLE GEAR (A) COLLAR	84	SENSOR SCREW (A)	129	DRAG LIP WASHER	202	CRAMP SCREW
40	IDLE GEAR (A)	85	SENSOR SCREW (B)	130	DRAG PACKING	203	CRAMP SCREW WASHER
41	IDLE GEAR (A) WASHER	86	FINGER COVER	131	DRAG O RING	204	CRAMP SCREW NUT
42	IDLE GEAR (A) SCREW	87	LINE GUARD	132	DRAG COLLAR	205	CRAMP PLATE NUT (SHORT)
43	IDLE GEAR (B) COLLAR	88	LINE GUARD SCREW	133	HANDLE BALL BEARING	206	CRAMP PLATE NUT (LONG)
44	IDLE GEAR (B)	89	FINGER COVER SCREW (A)	134	R/S COVER	207	LINE THROUGH
45	IDLE GEAR (B) WASHER	90	FINGER COVER SCREW (B)	135	R/S COVER BALL BEARING	208	DRIVER
46	IDLE GEAR (B) SCREW	91	JOG POWER LEVER (A)	136	R/S COVER BALL BEARING SCREW		

There may sometimes be a difference between the purchased reel and the Dismantled Parts Chart or the parts list above due to the adjustment process etc. We appreciate your understanding.

Trouble shooting

Symptom	Possible causes	To do	Ref. page
Motor does not respond to the power lever.	The counter displays 0.0 m.	It is a normal function to avoid over winding.	P30
	Did not pull the lever to OFF position.	Pull the lever to OFF and then move forward again to start winding.	P13
	Unstable power source.	Use another power source, such as electric reel specific batteries.	P9
Counter display does not appear.	Battery charge is low.	Recharge the battery.	P9
	Cord worn or corroded.	Replace the cord.	P11
	Incorrect battery connection.	Connect clips correctly without + / - reverse connection.	P8
Auto stop function does not work.	Did not press RESET BUTTON at surface.	Set the surface depth to zero after setting rig.	P30
	Error for sinker weight or rocking of the boat.	Adjust settings of auto stop function.	P31
	Line is elongated.	Reset the depth counter at the surface.	P30
There are counter errors.	Line length has increased due to stretching.	Re-enter line data.	P17~26
		Recalibrate the water depth.	P39
	Line was wound while powered off during fishing.	Re-enter line data.	P17~26
	RESET BUTTON was pressed and held while feeding the line.	Re-enter line data.	
Pickup does not respond.	Speed setting is at zero.	Go to the Menu screen to set the Jigging again.	P33
	Distance is already below +3 m from auto stop.	Designed not to wind in this range for safety.	P33
Jigging function does not respond.	Power lever is at OFF.	Set the jigging speed with the Jog Power Lever.	P34~36
	Pickup mode is selected.	Go to the Menu screen to set the Jigging.	

*Contact your dealer if the reel does not function properly despite the above details being confirmed, in the event of other problems arising, and to order parts.