

Tanacom Bull 10000

OPERATING MANUAL

Thank you for purchasing a TANACOM BULL 1000. To take full advantage of the reels many useful functions, please read this manual carefully before using. Retain this manual for future reference.

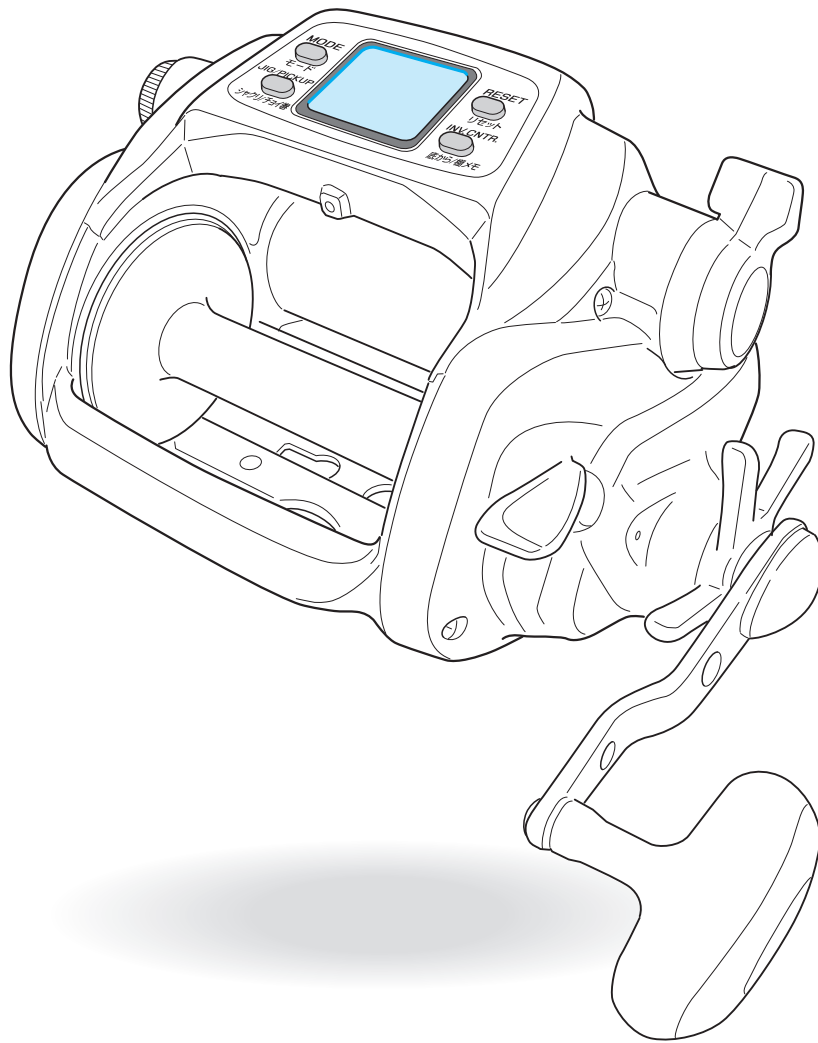

Reference







Index

Caution	1		
Precautions	1	11. Display recalibration	32
		Display revision	
Power source	2	12. How to fix the Rod Clamp	33
How to connect the reel to the power source	2		
About the power source	2	Useful functions	34
Battery checking displays	2	Various alarms	
		Display light	
		Breaker display	
Using the Reel	3		
About the counter display	3	Reel Specifications	35
		Reel Specification list	
		Counter display	
Maintenance	4		
About maintenance	4	Parts List	36
Maintenance procedure	4		
Handling and maintenance of the power cord	5	Trouble shooting	37
Other maintenance points	5		
Names of the buttons and the display	6,7		
Names and functions of each part	8,9		
Line data input	10-17		
With Input Roller	10,11		
When line length is known------(P1)	12,13		
With Backing line------(P2)	14,15		
Backing line 2------(P3)	16,17		
Functional setting operation	18-33		
1. Mode setting display	18,19		
How to set the many functions available			
2. Before you begin fishing	20		
Surface depth setting			
When the main line is cut or broken off.....			
3. Auto stop function	21		
Auto stop setting			
Auto stop			
4. Line sending function	22		
Line sending function			
5. Pickup speed setting	23		
Pickup speed preference			
6. Inverse counter	24		
Inverse counter			
7. Jigging	25-27		
Jigging			
Jigging master			
8. Winding speed indicator	28		
Winding speed display			
9. Remaining time to auto stop	29		
Displaying of the remaining time to auto stop			
10. Chumming timer winding	30,31		
Chumming timer winding			
Chumming timer			

Caution

Precautions

Warning		1. Be careful to keep fingers clear of the levelwind mechanism. It can pinch your fingers and cause injuries.
		1. If your sinker or lure is caught on the bottom, cut your line rather than jerk the rod to free it. 2. After fishing, rinse and dry the reel thoroughly. Store in a dry place. 3. Handle the reel with care. Dropping it may cause damage. 4. Do not touch the line while reel is running. It could cut your skin. 5. Use this reel for fishing purposes only. 6. Be careful not to get reel grease on your clothing. 7. Do not use metal wire for the main line. 8. Sharp impacts due to inadvertent drop or other reasons may cause reel body breakage, damage to the inner electronic components, and cracks or short circuit of the board, resulting in functional disability.
Attention		1. When you use a power source other than the battery or the power source provided by the boat, be sure it is of the proper voltage. Excess voltage will harm the reel and may generate enough heat to burn your hands. 2. Do not use badly rusted cord to prevent electrical heat.
		1. Do not touch moving parts while the reel is operating or it may cause injury. 2. Drag adjustment should only be done with the auto winding functions off.
		1. Do not disassemble the reel. It could result in malfunction that could damage the reel or cause personal injury.

About the counter display

The following conditions may make the display difficult to read.

1. Wearing of polarized glasses.
2. Excessively cold or hot weather, mid-winter (display's surface temperature is below -10 degrees centigrade) and mid-summer (display's surface temperature is above 60 degrees centigrade).
3. When light strikes the display from certain angles, the display's digits may have shadows. This does not affect its function.

Do not reel in the end of the line

DO NOT allow end of line to be wound onto the spool. This may cause synchronization with the levelwind to be lost, a condition that can damage the levelwind due to the reel's high power output. Should this happen, line should be removed from spool and rewind.

After each trip, attach line to line clip to prevent it accidentally being wound onto reel.

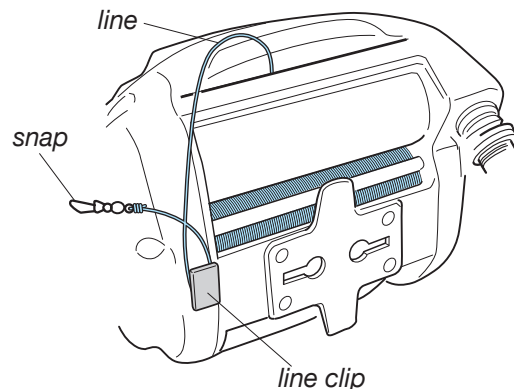
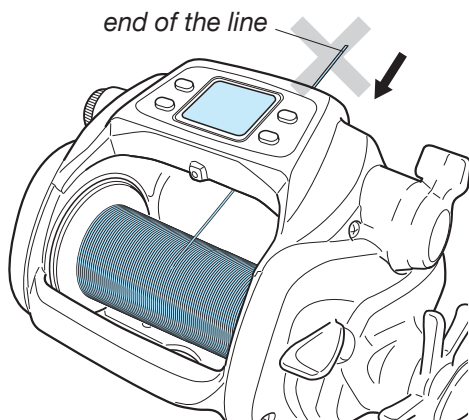

Power source

How to connect the reel to the power source

1. Attach the cord clips to the battery. Red covered clip is the plus (+), and the black covered clip is the minus (-).
2. Insert the connector into the reel. After this, the display appears as below. By taking the appropriate steps, the indication will change as shown below and the data will be set.

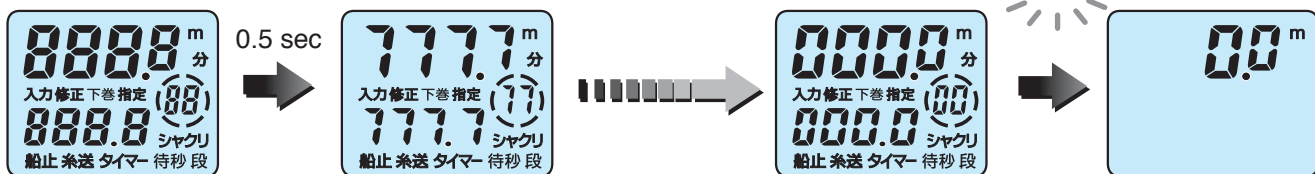
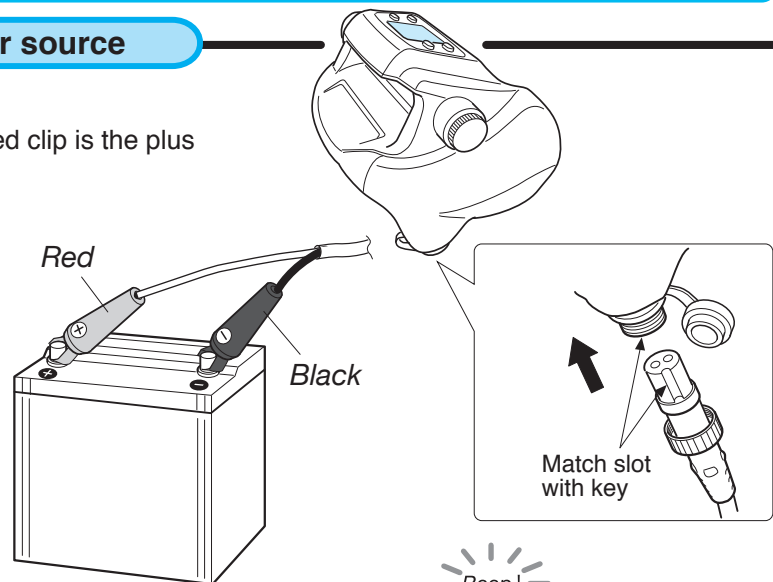

1. When changing batteries, the display's backup memory stays active for about 15 minutes after the old battery is disconnected. Thus the above display startup sequence does not need to replay when the new battery is connected within the 15 minute time frame.

About the power source

This reel is made to accept DC 12 Volt power only. Power sources providing other than this cannot be used. The power provided by a boat can be unstable, causing the reel to stop unintentionally. Please use a battery made specifically for fishing reels, such as our lithium battery pack or marine battery.

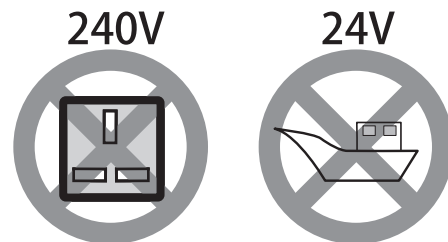

Make sure of the following before departure.

1. Recharge the battery before your fishing trip. Over time, a battery can naturally discharge.
2. Confirm the boat can provide the proper power source (i.e. voltage, connector shape etc).
3. Corroded connections can prevent the flow of electric current. Remove any corrosion or dirt from the connectors.

Battery indicator

With power on, digits of the inverse counter (counter in the lower area) will blink if voltage gets below DC 9 V. If the display shows this when the motor is not running, then battery voltage is likely to be low. In this case, replace the battery with a recharged one.

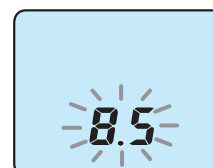

This figure shows the voltage is 8.5 V

Using the Reel

1. Do not jerk your rod to free a lure or sinker stuck on the bottom. Pull the line taught with a gloved hand and cut it.
2. After maintenance, be sure to loosen the drag and store the reel in a dry place.
3. Handle the reel with care to avoid dropping and possibly damaging it.
4. Do not use metal wire as the reel's main line.

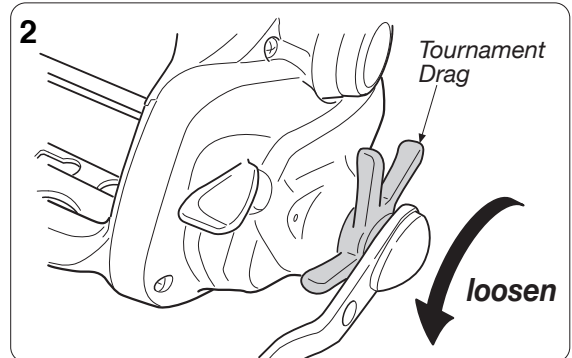
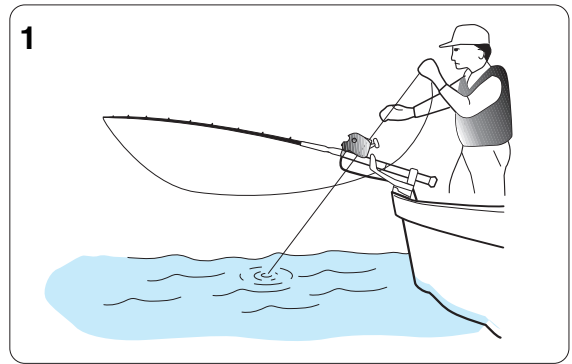

About the counter display

The following conditions may make the display difficult to read.

1. Wearing polarized glasses.
2. Excessively cold or hot weather, mid-winter (display's surface temperature is below -10 degrees centigrade) and mid-summer (display's surface temperature is above 60 degrees centigrade).
3. When light strikes the display from certain angles, the display's digits may have shadows. This does not affect its function.

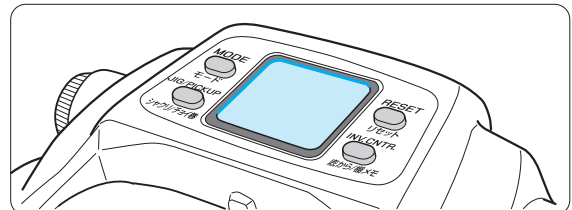

Maintenance

About maintenance

This is a washable reel. Wash away salt residue and grit after fishing.

Maintenance procedure

1. Wash the reel with a dish washing detergent and a soft sponge. Do not use solvents.

Do not use soap or other detergents. Other soaps or solutions may damage the reel both externally and internally. The solution may damage the outside coating of the reel and may breakdown the grease inside of the reel creating an overflow of grease.

2. Rinse detergent and dirt away with running water, rinsing the spool very well to get rid of salt. Use warm water, under 30 degrees centigrade.

3. Dry the reel well.

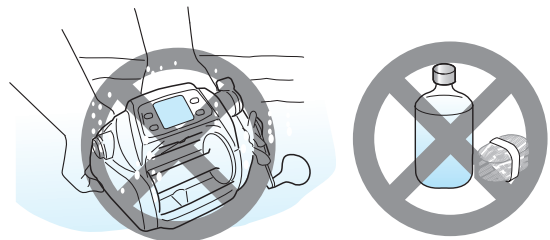
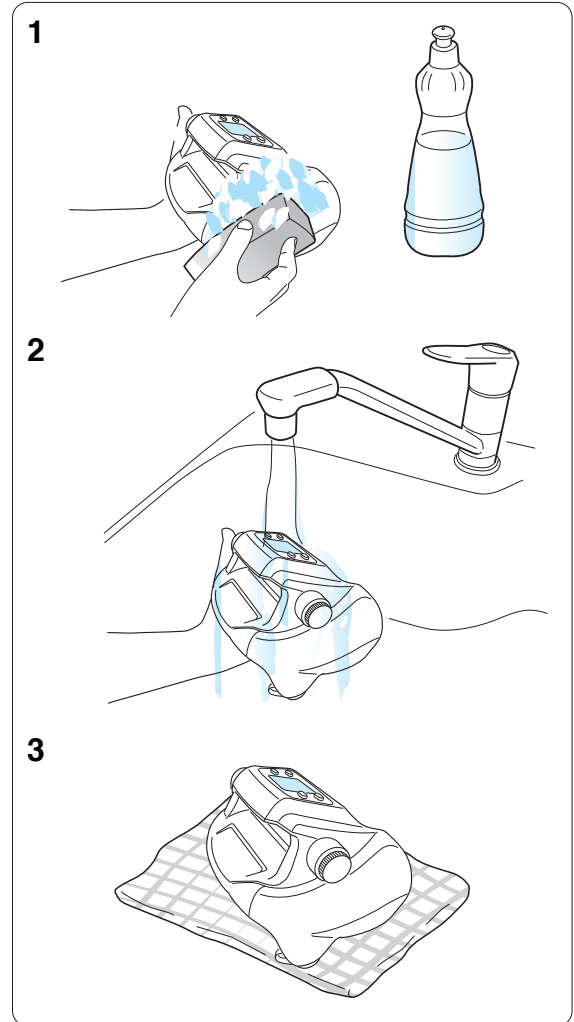

1. Do not submerge the reel when washing.
2. Do not use organic solvents such as benzene and thinner.
3. Do not use a steel brush or abrasive cleanser.

Maintenance

Handling and maintenance of the power cord

Follow the restrictions below to avoid cord problems. Do not cut or connect your cord by yourself as it can cause unintended problems.

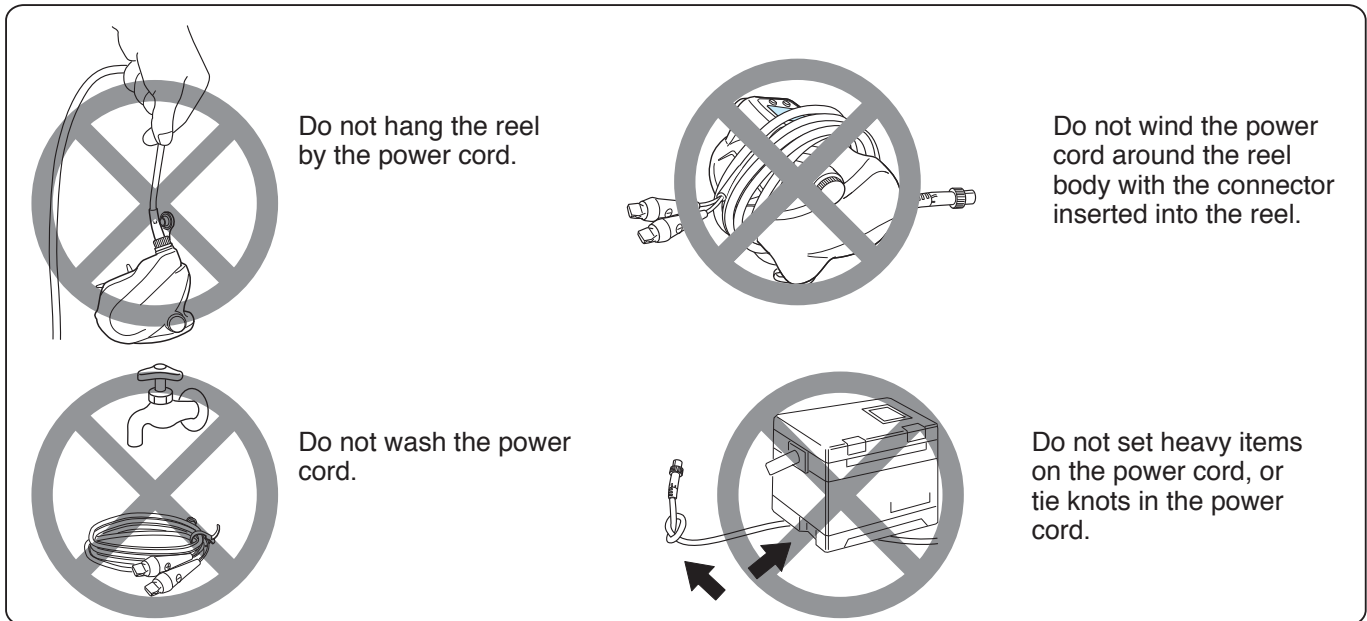

Maintenance of the power cord

- Wipe the power cord with a wet cloth and dry it well.
- Pay special attention to drying the tips, with cover removed.
- Grease the connector after it is dried.
- Disconnect the power cord from the reel before storing.

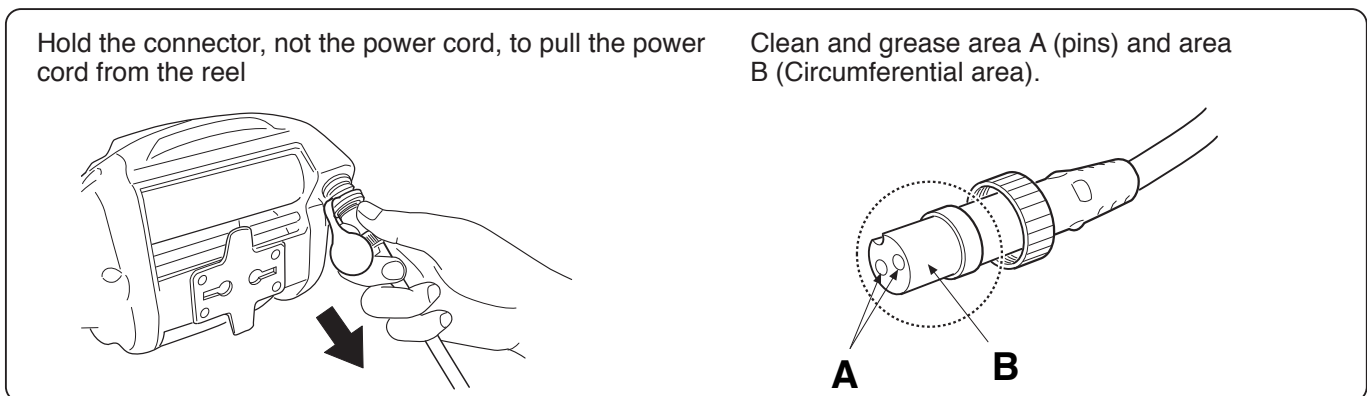

Other maintenance points

- This reel is a precision instrument that employs electric circuitry and motor. Do not disassemble the reel by yourself.
- Cover the power connector on the reel with its protection cap.
- Old or worn cords can cause a bad connection and/or short circuit. Replace the cord every 2 years.

Names of the buttons and the display

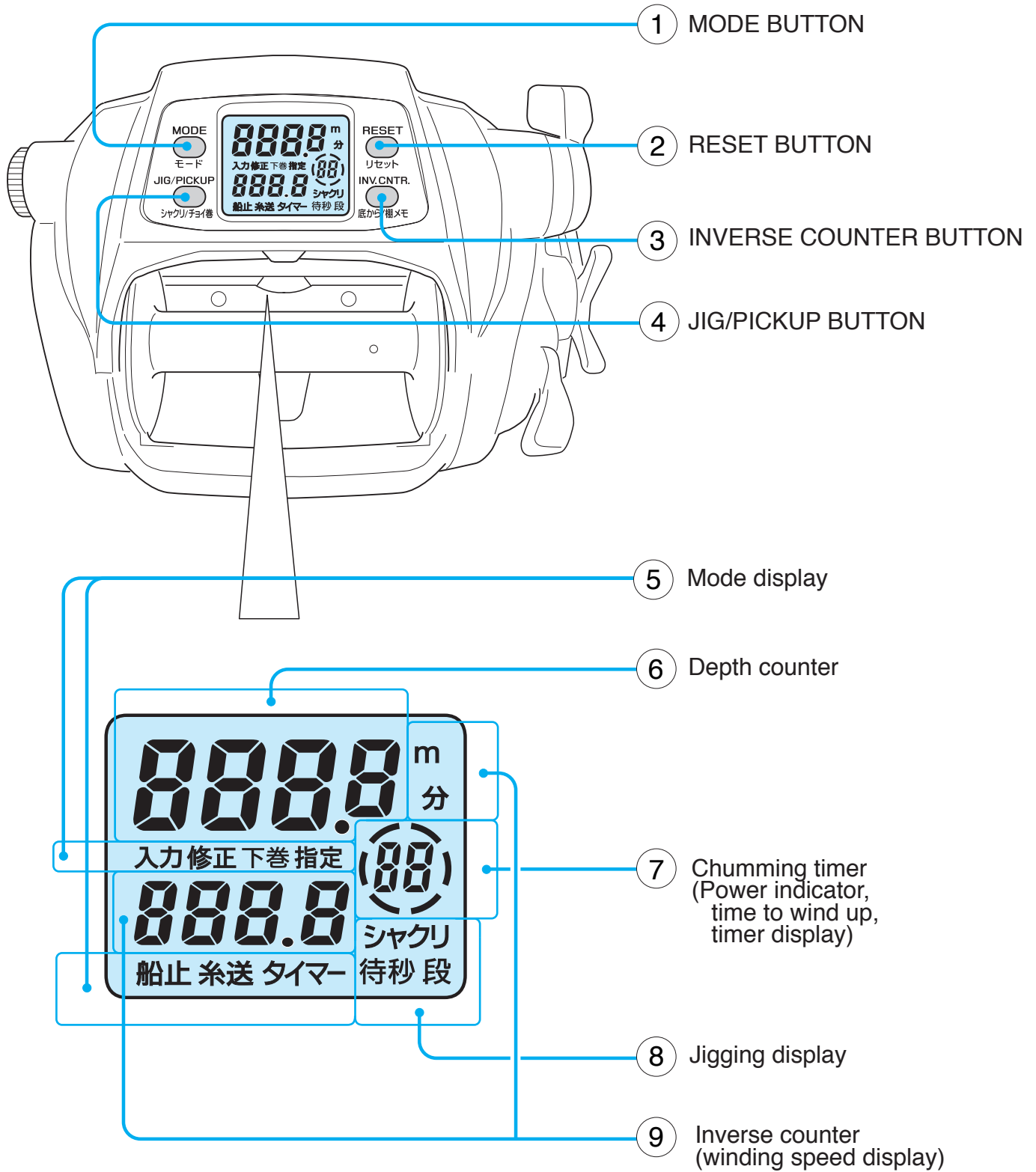

Names of the buttons and the display

① MODE BUTTON

Press the **MODE BUTTON** to scroll through the adjustment displays for each reel function.

- Use the Power Lever to adjust numeric values.
- Pressing the **MODE BUTTON** sets the numeric values you have adjusted.
- Depress and hold the **MODE BUTTON** to return to the depth display.
- Mode change cannot be done while line is being fed.

② RESET BUTTON

This button resets the depth counter to zero.

Make sure to press this button before you start fishing. The reset depth is used to make the auto stop function work. (display shows **船止**). The default setting of auto stop is 2 meters.

This prevents accidental resetting. For a total reset, when line has been broken off, press and hold the button for at least 2 seconds.

③ INVERSE COUNTER BUTTON

Pressing this button resets the counter in the lower area of the display.

- It memorizes distance from the bottom, handy for dropping a bait right back into the strike zone after you've been bit.
- The chumming timer resumes after pressing this button.

④ JIG/PICKUP BUTTON

Selection between pickup and jigging can be done in the mode setting display. (One of them should necessarily be chosen.)

Pickup

- You can wind only while pressing this button. This function is useful to wind up line slack and attract fish.
- Winding speed can be changed with the mode setting display. (Default setting is speed 15)

Jigging

- Jigging can be ON/OFF.
- Pressing this button starts jigging. (Display shows)
- Pressing the button again stops jigging.

⑤ Mode display

- This display allows you to change setting of each function.
- The functions that are set to work are shown on the display. (Default setting is speed 15, but the speed can actually be set between 0~Hi.)

Display	Function	Display	Function
シャクリ	Pressing the JIG/PICKUP BUTTON makes the function work. Pressing the button again stops it.	船止	Pressing the RESET BUTTON makes this indicator appear, telling you auto stop will work.
タイマー	Chumming timer starts working.	チョイ巻	Only while pressing the JIG/PICKUP BUTTON will the motor run to wind line.
糸送	Auto Line feeding is employed. Default setting is off.		

⑥ Depth counter

- It shows the depth from the surface.

⑦ Chumming timer (Power indicator, time to wind up, timer display)

- The chumming timer appears when motor rotation is stopped. The timer display cannot be set to OFF.
- While using the power lever, the power level is shown.
- While the electric winding up is in action displaying actual winding speed, the timer indicates the remaining time to auto stop at the ship side (in minutes and seconds).

⑧ Jigging display

- This is appeared only when the jigging function is on.
- It blinks when jigging is in process.

⑨ Inverse counter (winding speed display)

- This counter shows the depth from the bottom (or a certain depth).
- Once this counter is turned on, its display cannot be turned off.
- While winding up, winding speed appears in meters per minute. (The display of winding speed can be set to OFF)

Names and functions of each part

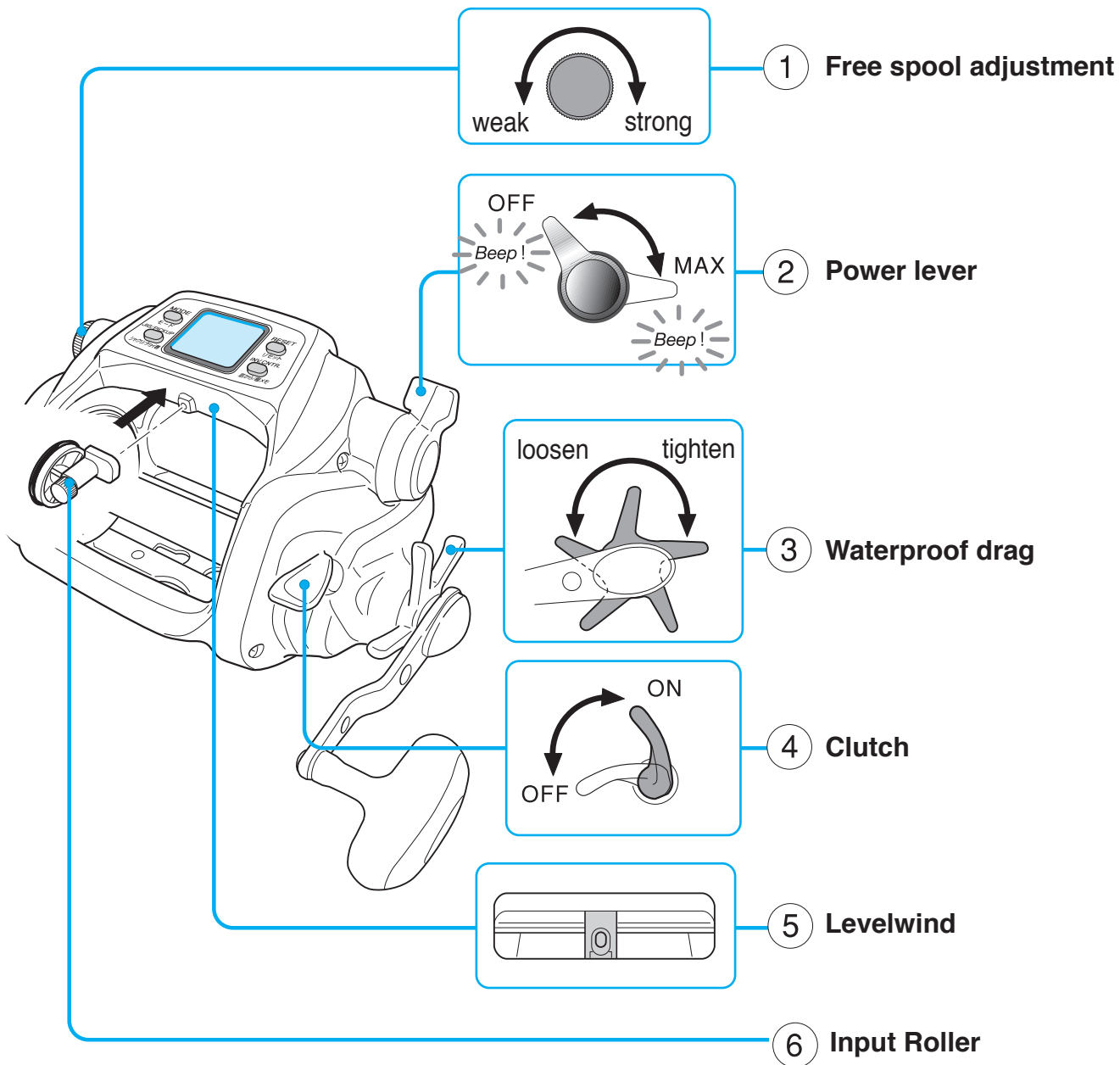

7 Enclosed items

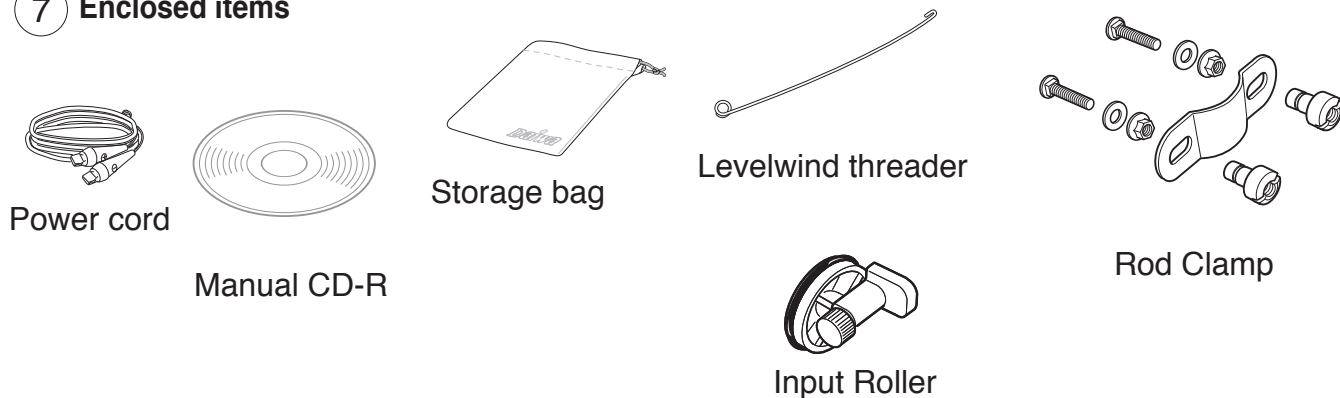

Names and functions of each part

1 Free spool adjustment

- It adjusts brake tension on the spool to prevent backlash or line slack caused by dropping the line with hook and sinker.

2 Power lever

- You can freely adjust winding power, or winding speed, from zero(ON/OFF) to maximum, by 32 steps, by using the lever.
- Tilting the lever forward adds power and speeds up the winding.
- Pulling the lever back slows down the winding.
- Without the lever positioned to OFF, it is impossible to start winding. You have to pull it back to the OFF position before you start winding. An audible sound indicates the OFF position.
- The power lever is used to set numerical values on the various function displays.

3 Waterproof drag

- Adjusting the star drag allows the spool to slip against a strong pull to avoid line breakage.
- (1) Adjust the drag while reel is on the rod and the line is strung through all the line guides.
 - (2) Adjust drag with the clutch ON, while pulling the line with your hands. Normally, the drag is adjusted to prevent the weakest line in the line system from breaking.

4 Clutch

- Turning the handle automatically engages the clutch.
- ON position > line winding can be done.
- OFF position > spool is free-turning to let out line.

5 Levelwind

- The levelwind distributes line evenly on the spool as you wind it in.
(Under some special circumstances line may not wind evenly because of the clearance between the levelwind and the line.)

6 Input Roller

- Put the rough sides together and fix in place with screws. When installed and connected to the power, it will set to Automatic Input mode.

7 Enclosed items

- Power cord
- Manual CD-R
- Storage Bag
- Levelwind threader (This tool simplifies threading line through the levelwind.)
- Input Roller
- Rod Clamp

Line data input (with Input Roller)



You can also set the main line utilizing the Input Roller.

See animation

Line data input
With Input Roller

1. Run the line through the Levelwind Guide and tie it onto the spool.

The Levelwind Threader, one of the accessories, makes this process easier.
Make sure of tying the line onto the Thread Pin to avoid the line slipping on the spool surface.

2. Connect the battery to the reel.

3. Move the Power Lever to the user's side, namely to the OFF position.

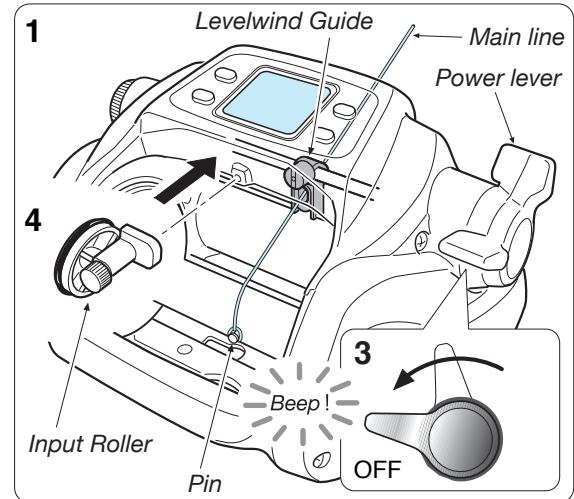

4. Attach the Input Roller, sold separately, to the reel. You will then hear a beep sound confirming that the reel has entered into the Automatic Input mode.

Tighten the drag to give enough line tension in order to wind line without slipping.

5. Push the Power Lever forward to maximum and wind the line.

When the Power Lever is moved forward, the number on the lower right portion of the display changes into a tension indicator, and number of the counter on the upper portion of the display begins to increase.

Keep line tension between level "5" and "7" while winding the line. As line winding continues, the displayed number of the counter increases.

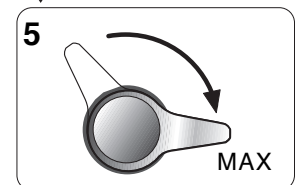
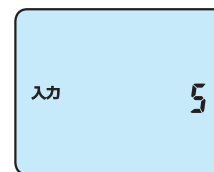
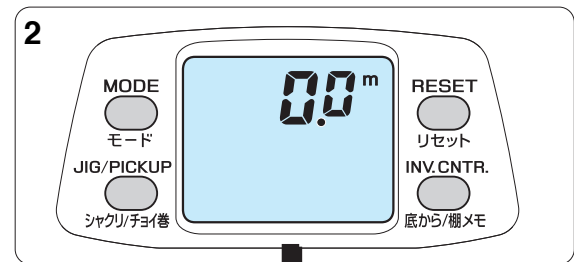

6. Continue winding the line until the line touches the Input Roller.

When the line reaches the Input Roller, the latter begins to rotate so that the winding may stop automatically.

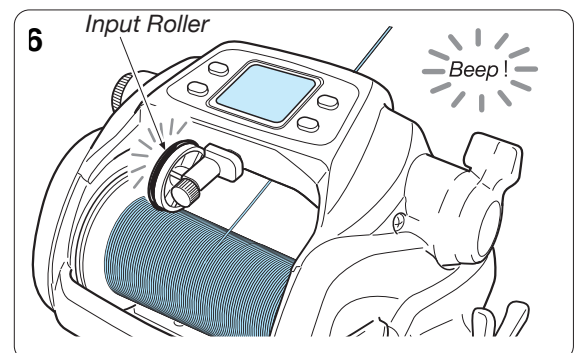

Line data input (with Input Roller)

7. Take off the Input Roller.

8. Pull the Power Lever to the OFF position once again. (The beep will then be heard).

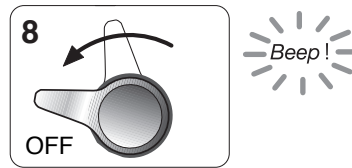

9. Push the Power Lever forward again to maximum and wind the remaining line to fill the spool.

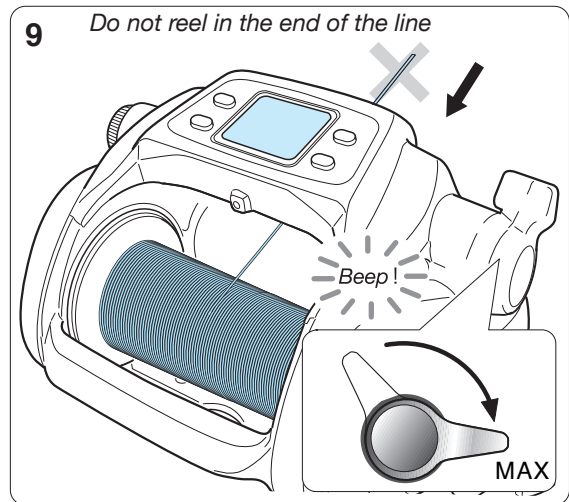

1. Do not allow line to rub against the finger guard while winding as it will scratch the guard.
2. The motor can be overloaded when winding at very high tension for a long time (about 15 minutes). In this case, the motor will automatically stop. When winding the line at high speed (less line tension is required). This does not occur while fishing as water helps cool down the motor. If the motor stops, wind manually or move the power lever momentarily back to OFF and then resume winding.
3. Do not wind the end of the line onto the spool because it causes incorrect length calculation. Move the power lever to OFF, and wind manually when nearing the end of the line.

10. After winding, pull the Power Lever to the OFF position. (The beep will then be heard).

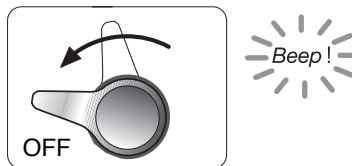

11. Press **RESET BUTTON** for longer than 2 seconds until the beep sound is heard. The display should then return to **0.0**, indicating the completion of the setting procedure.

Should "Err" appear on the display, then use the **MODE SET BUTTON** to re-enter the data.

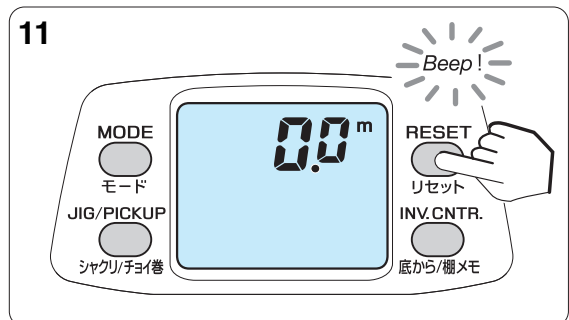

Line data input (When line length is known)

This method is used when the line length is known before winding. In the example below, PE 6 – 1000m is wound.

1. Run line through the levelwind guide and tie it onto the spool. The levelwind threader makes this process easier. Make sure to tie the line onto the pin found on the spool to avoid the line slipping.

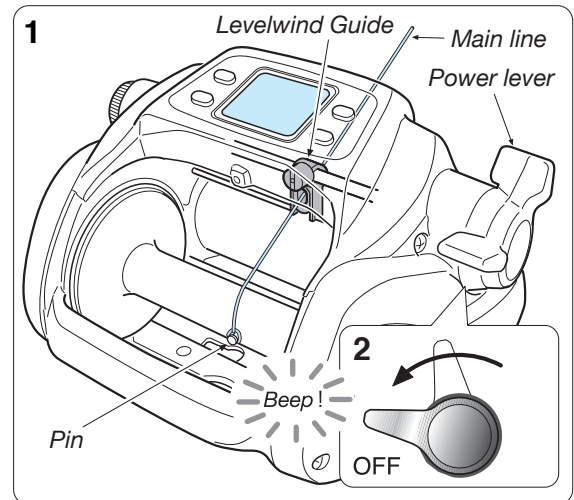

2. Move the power lever to the OFF position.

3. Press the **MODE SETTING BUTTON** and hold for five seconds, until the display shows 0.0. When the button is released, the display will then change to the figure on the right, which shows P1.

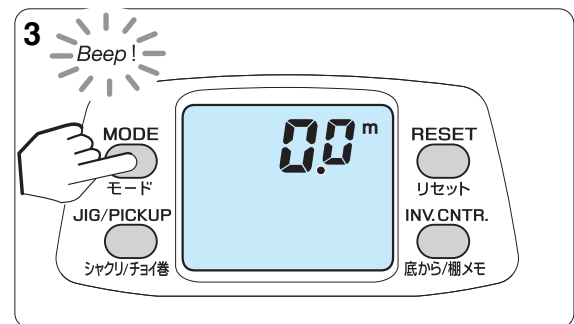

Make sure the drag is set firmly.

4. Push the power lever forward to maximum and wind the line to its end. As the power lever is moved forward, the P1 display changes to a tension indicator. Keep line tension between level 5 and 7 while winding on line.

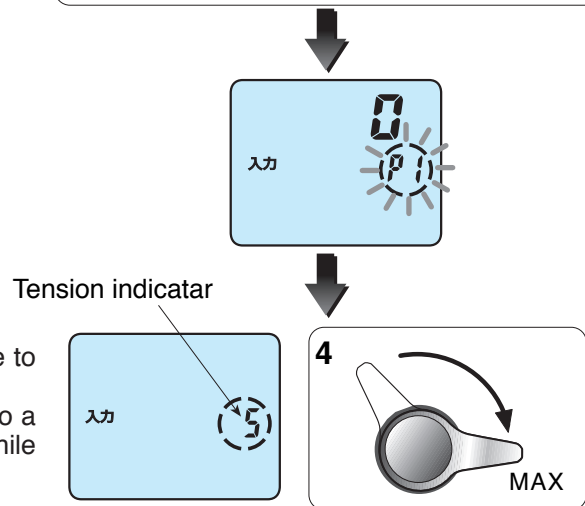

1. Do not allow line to rub against the finger guard while winding as it will scratch the guard.
2. The motor can be overloaded when winding at very high tension for a long time (about 15 minutes). In this case, the motor will automatically stop. This does not occur while fishing as water helps cool down the motor. If the motor stops, wind manually or move the power lever momentarily back to OFF and then resume winding. Wind the line at high speed (less tension).

Line data input (When line length is known)

5. Pull the lever back to the OFF position, after winding.

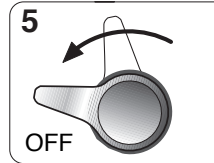

1. Do not wind the end of the line onto the spool because it causes incorrect length calculation. Move the power lever to OFF, and wind manually when nearing the end of the line.

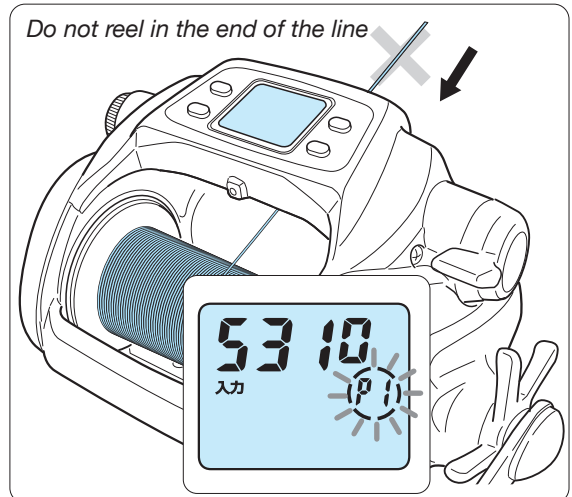

6. Press **RESET BUTTON** for 2 seconds, until the display shows **800**. (800 is the default setting)

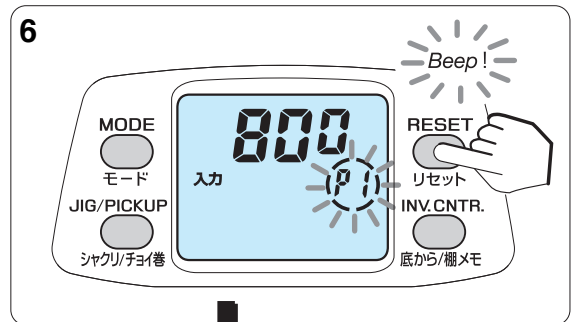

7. Enter the line length with the power lever. (in the figure on the right, line length is 1000 m).

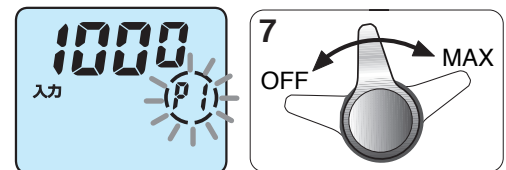

8. Press **RESET BUTTON** for 2 seconds and a beep will be heard. The display should return to **0.0**, completing the setting procedure.

If "Err" appears on the display, you must use the **MODE SET BUTTON** to re-enter the data.

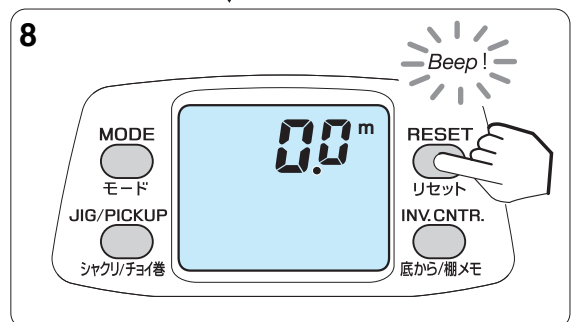

Line data input (With backing line)

This method requires use of Daiwa braided line that is color coded to show length and has a total length greater than 100 m.

1. Run the backing line through the levelwind guide and tie it onto the spool. The levelwind threader makes this process easier. Make sure to tie the line onto the pin found on the spool to avoid the line slipping.

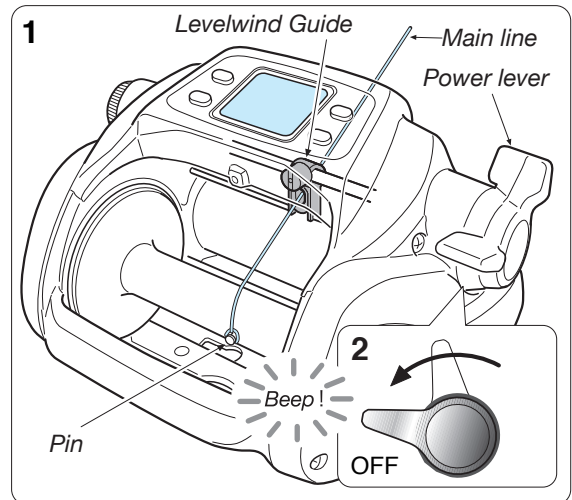

2. Wind the backing line.
If the power lever is not already at OFF position, then pull it back to OFF position before beginning to wind.

3. Tie the backing line securely to the main line.

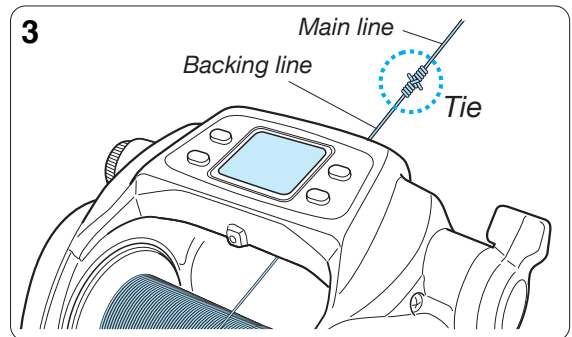

4. Press the **MODE BUTTON** for 5 seconds, when the display will show **0.0**.
P1 will be blinking.

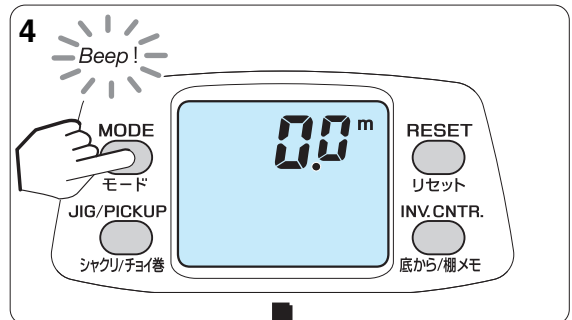

5. Press the **MODE BUTTON** twice and change the display to backing line input.
P2 will then be blinking.

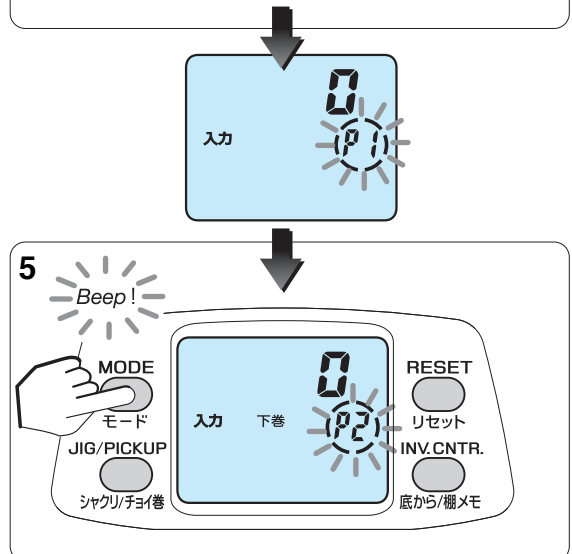

Line data input (With backing line)

6. As indicated by the line's color coding, wind the line up until the remaining line is 100m.
With the power lever moved forward, P2 changes into a tension indicator. Keep line tension between 5 and 7 while winding.

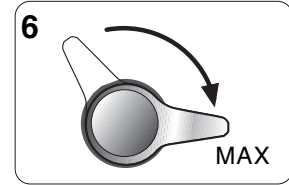

1. Do not allow line to rub against the finger guard while winding as it will scratch the guard.
2. The motor can be overloaded when winding at very high tension for a long time (about 15 minutes). In this case, the motor will automatically stop. This does not occur while fishing as water helps cool down the motor. If the motor stops, wind manually or move the power lever momentarily back to OFF and then resume winding. Wind the line at high speed (less tension).

7. Press **RESET BUTTON** for 2 seconds.
P2 blinks and the counter in the lower area shows 50. The upper counter digits increase as line is wound.
8. Wind on another 50 m of line, keeping line tension at the suggested level.

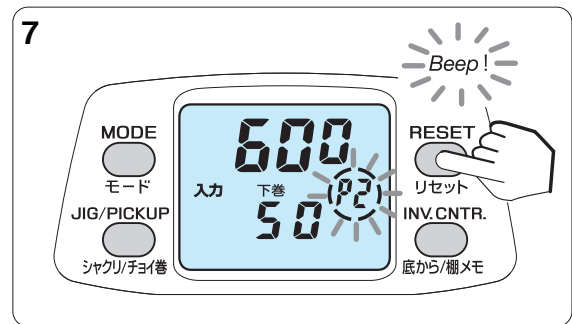

9. Press **RESET BUTTON** for 2 seconds.
The lower counter shows 100.
10. Wind the remaining 50m, keeping line tension at the suggested level. Do not wind line all the way onto the spool.

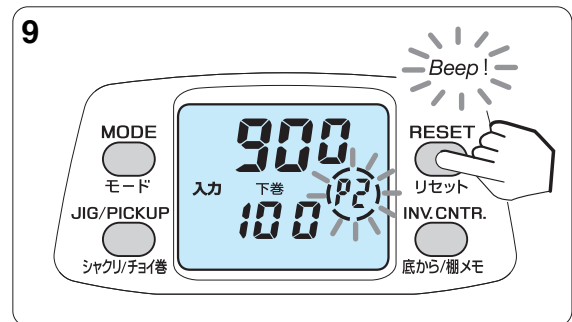

11. Press **RESET BUTTON** for 2 seconds and 0.0 will appear.
This is the end of the procedure.

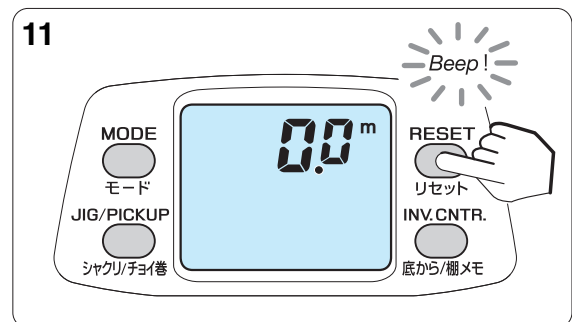

1. Do not wind the end of the line onto the spool because it causes incorrect length calculation. Move the power lever to OFF, and wind manually when nearing the end of the line.

Should "Err" appear on the display, then use the **MODE SET BUTTON** to re-enter the data.

Line data input (Backing line 2)

This procedure is to enter the line length after it has been wound onto the reel. It is necessary that you know the line length and that it is greater than 100m.

1. Connect the battery to the reel.
2. Press the **MODE SET BUTTON** for 5 seconds, changing the mode to **P1**.

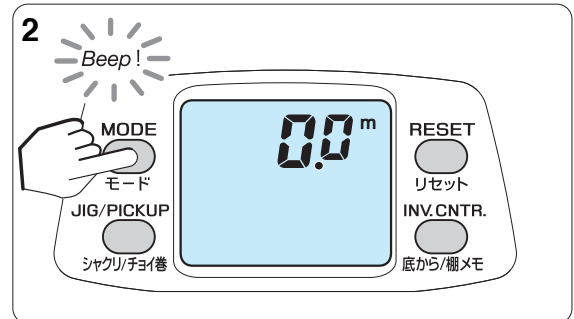

3. Press the **MODE SET BUTTON** 2 more times and set the mode to backing line 2. This mode shows **P3** blinking on the low left of the display.

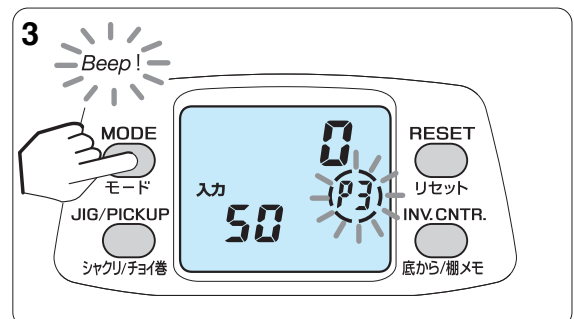

4. Paying attention to the line's color coding, pull 50m of line off of the spool.

5. Press the **RESET BUTTON** for 2 seconds. This will show the digits **100** in the lower area of the counter.

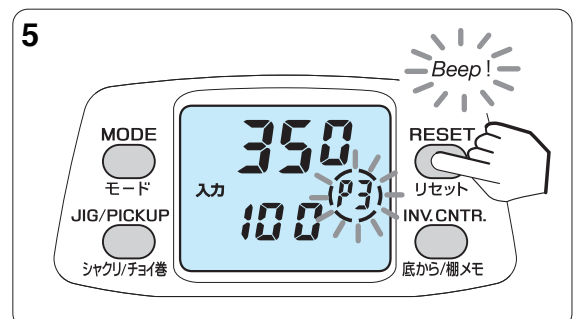

Line data input (Backing line 2)

- Pull an additional 50m of line from the spool.
- Press the **RESET BUTTON** for 2 seconds to show **100.0** on the upper counter.
- Wind up the 100m of line you pulled from the reel. This completes the procedure.

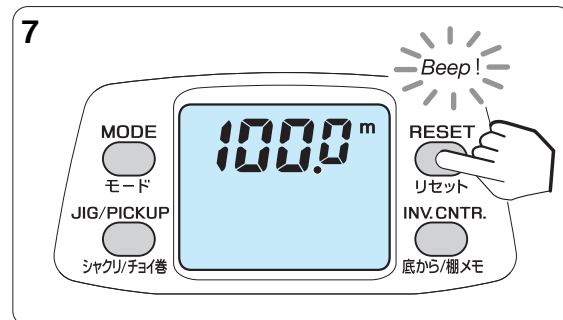

- Do not wind the end of the line onto the spool because it causes incorrect length calculation. Move the power lever to OFF, and wind manually when nearing the end of the line.
- There are cases in which the length of the line will not be displayed if it exceeds 100m when entered with this method.

Should “Err” appear on the display, then use the **MODE SET BUTTON** to re-enter the data.

Functional setting operation (1. Mode setting display)

How to set the many functions available

1. There are many useful functions in the mode
2. Use the power lever to change numerical values on the setting displays for each function. Complete your adjustments and lock in the values by pressing the **MODE BUTTON**.

1. Press the **MODE BUTTON** to choose a display.

Each press of the **MODE BUTTON** changes the display to the next function.

Holding the **MODE BUTTON** down, rapidly scrolls through the displays, quickly getting you back to the depth display.

At each mode setting display, the default setting can be retained by pressing the **RESET BUTTON**.

While letting out or winding line, the **MODE BUTTON** cannot be used to change settings.

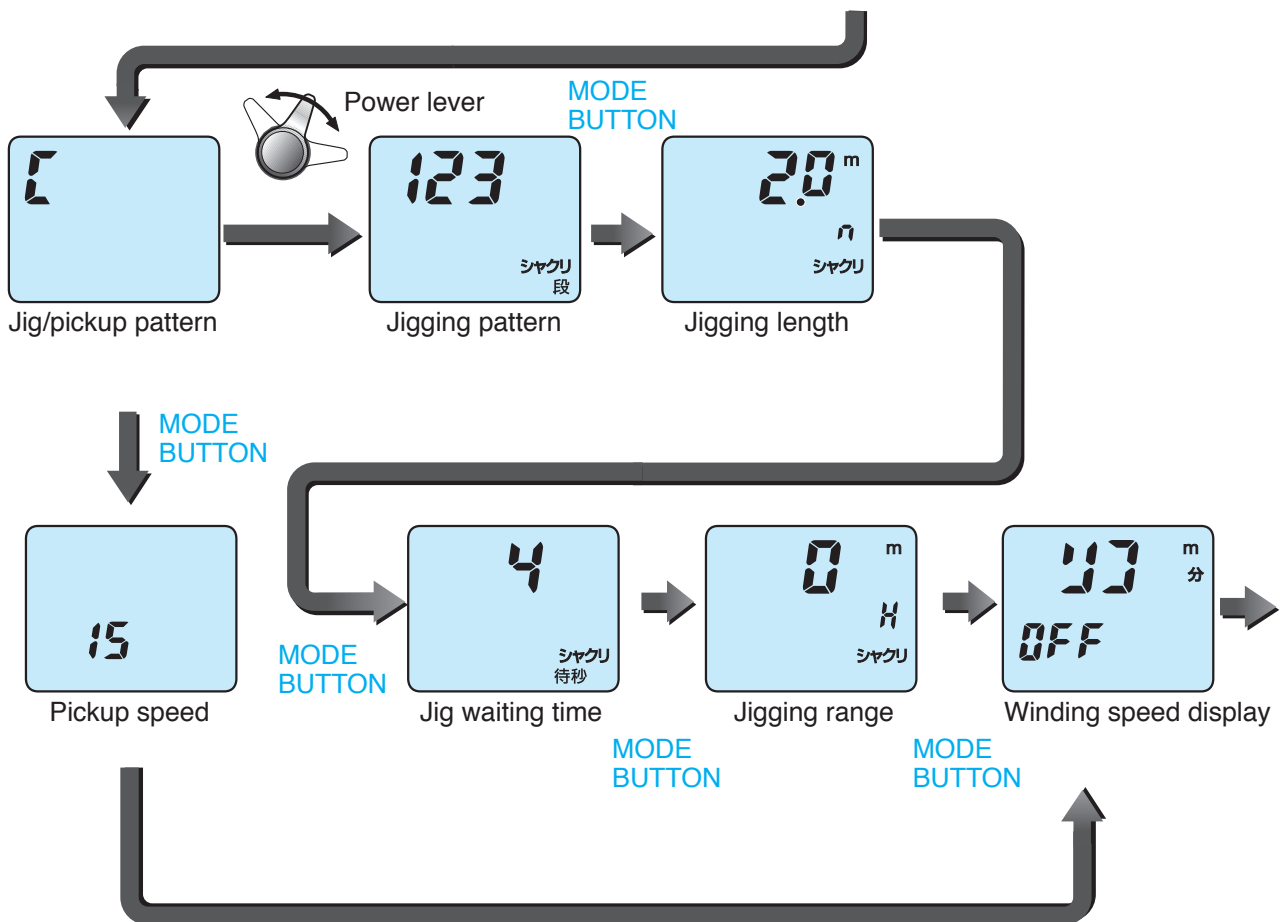
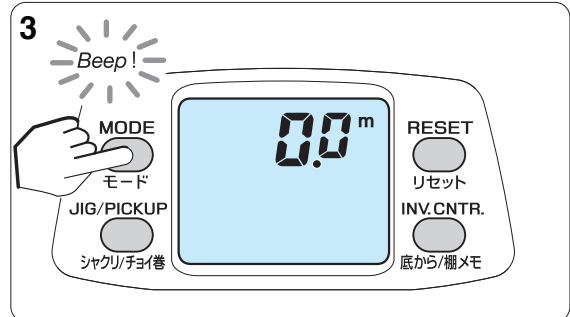

Functional setting operation (1. Mode setting display)

2. Use the power lever to set numerical values.

At its MAX position, numbers count upward rapidly. At the OFF position, numbers count downward rapidly. Around mid position, numbers change at a slower pace.

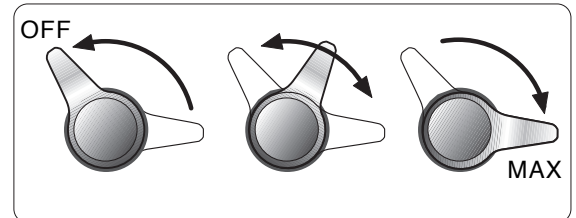
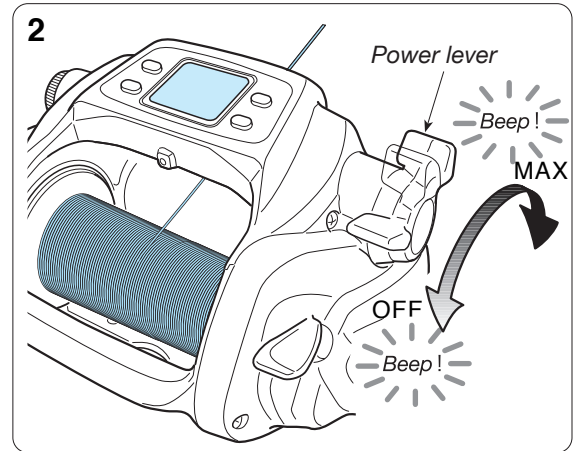

3. Press **MODE BUTTON** to complete the setting.

Pressing the mode button locks in the values you have set and moves on to the next display. Depress and hold the **MODE BUTTON** to rapidly scroll back to the depth counter screen. Pressing the **RESET BUTTON** at a setting display returns numbers to their default values (This resetting does not apply to the fishing record display.)

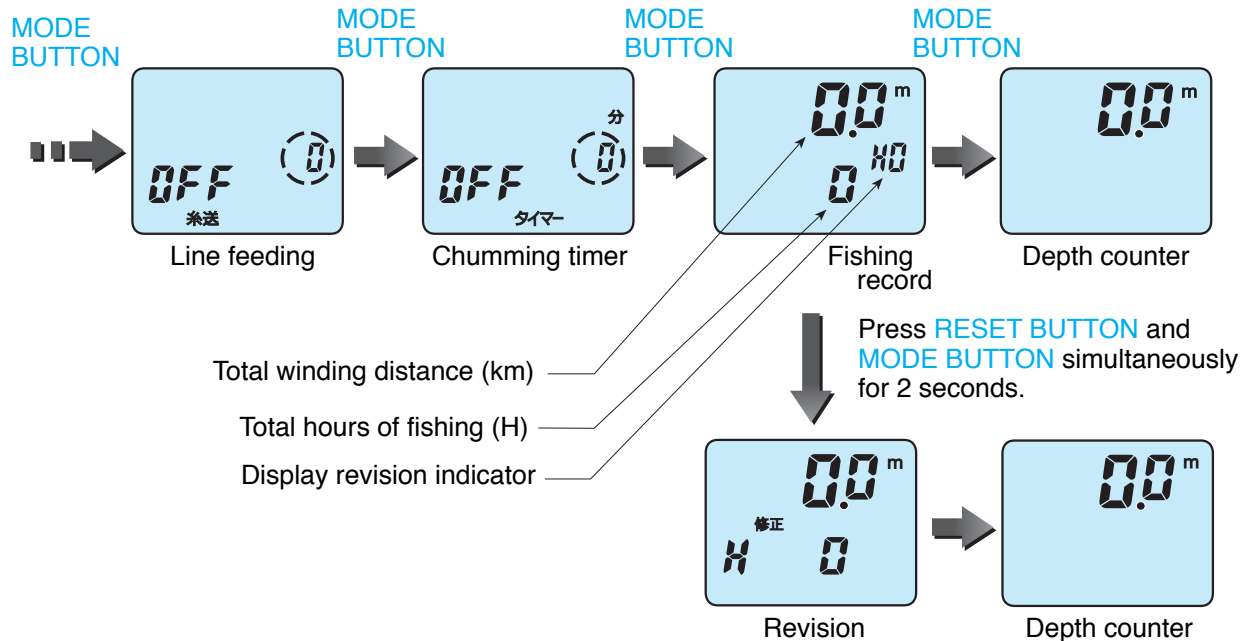
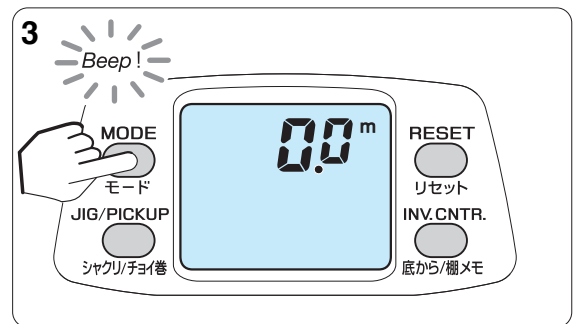

Functional setting operation (2. Before you begin fishing.)

Surface depth setting

Before you begin fishing, make sure the counter is set to zero at the water's surface. This is extremely important to ensure accurate fishing depth readings.

1. Connect the reel to the battery, put the line through all the guides, and prepare your terminal rig.
2. Place the rod into the rod holder in the position it will normally rest while fishing.

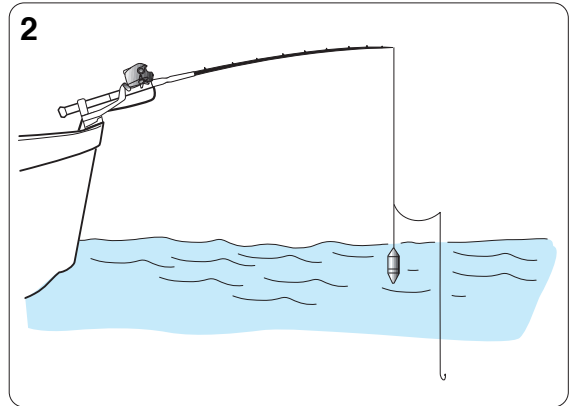

3. Lower the terminal rig to the water's surface and press the **RESET BUTTON**. (water surface zero setting)

The display resets to 0.0 and 船台止 blinks.

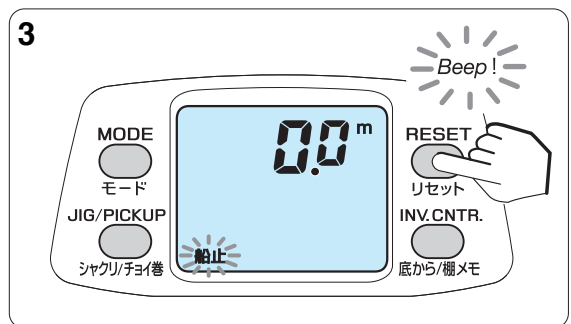

⚠ Attention

1. When new line is wound up, or when line has been pulled under heavy tension, line stretch may cause a gap in the depth reading at the surface. Simply reset the surface setting with the reset button.

When the main line is cut or broken off.....

- Should your line break, revise data as follows.
- Wind the line to the rod tip, and press the **RESET BUTTON** for 3 seconds. (At depths greater than 10 m, 3-second-pressing is employed accidental pressing of the button.) If the display shows 0.0 then your re-adjustment is complete and data has been revised.
- Unless you reset the data on the reel, it will not be able to count accurately.

Functional setting operation (3. Auto stop function)

Auto stop setting

The Auto stop depth may be set to meet your own specific needs.

- Auto stop adjusts to operate at depths from 1 m to 5 m (in 10 cm increments).
- It prevents accidentally winding swivels, terminal rigs etc. into the rod tip and stops your rig at a consistent depth for convenient checking and changing of baits and sinkers.
- Line stretch can cause an inaccurate reading at the surface. Simply reset the counter to zero at the surface.

1. Connect the reel to the battery, and press the **RESET BUTTON** with your terminal rig at the surface. The display shows **0.0**.

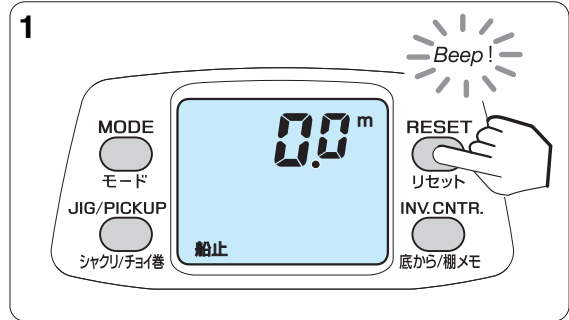

2. Raise the rod and adjust the line length from the rod tip so you can reach the rig easily. In the figure, its length is 1.5 m.



Checking and changing sinkers, baits etc.

Use

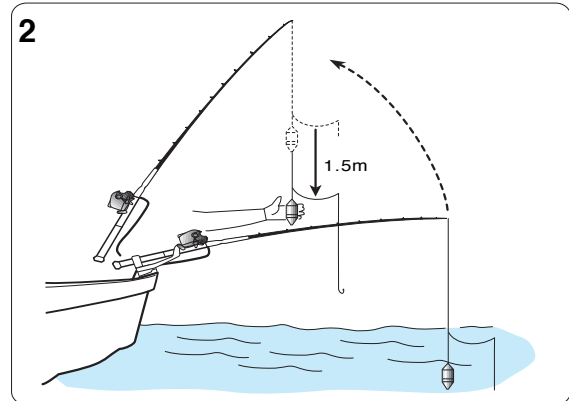

3. After adjusting length, press the **INVERSE COUNTER BUTTON** for 2 seconds.

When blinks, this procedure is completed.

Default setting is 2.0 m. (Without pressing the **RESET BUTTON** the winding stops at a depth of 5.0 m.

The **船止** lamp will blink when the setup has been completed.

4. When checking or changing a bait, simply wait until the reel automatically stops winding and raise the rod tip.

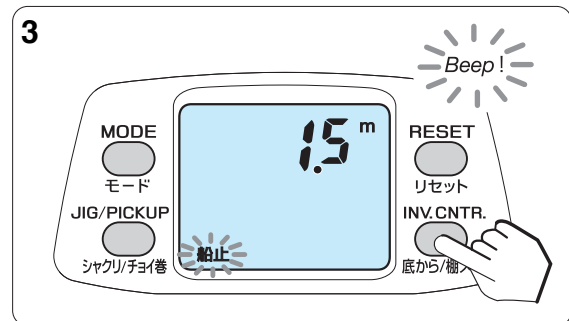

Auto stop

Auto stop automatically brings your terminal rig to the surface, stopping consistently at your pre-set depth preference. It eliminates the need to constantly monitor depth as it comes up.

- The auto stop function assists when winding with the power lever, jigging, or winding with the chumming timer.
- After the rig is ready, reset the depth counter to zero by pressing the **RESET BUTTON**. (water surface zero setting) (After this, **船止** appears on the display)
- Without pressing the **RESET BUTTON**, winding stops at a depth of 5 m.
- If you have pressed the **RESET BUTTON**, the alarm sounds at 2m increments above the depth of 8 m, and winding stops at 2 m.
- When auto stop depth is set, the alarm sounds every 2 m above the depth of 6 m, and winding stops at the set depth.
- After auto stop stops winding, the power lever can be used up to **0.0** m. However, above **0.0** m, motor winding such as, power lever and PICKUP, cannot be employed until the **RESET BUTTON** is pressed.
- Depending upon the rocking of the boat or sinker weight, auto stop depth can overrun slightly. Should this happen, increase the depth of the auto stop.

Functional setting operation (4. Line feeding function)

Line feeding function

The line feeding function lets our line with the motor assisting the spool.

- The line feeding mechanism begins to work at a depth of 2.5 m below the pre-set auto stop depth.
- If the clutch becomes ON while the reel is furnishing line, the spool begins to rotate to avoid line slack.
- Speed of the line going out is adjusted with 32 speed levels ranging between 0 and Hi. It is adjusted in the line feeding mode.

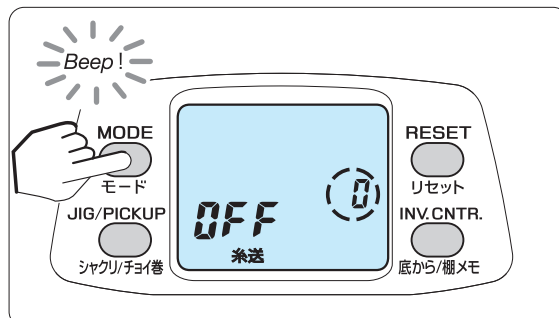

1. Press the **MODE BUTTON** to show the line feeding speed adjustment display. Default setting is zero (OFF). Set the speed level with the power lever.
2. Press the **MODE BUTTON** three times to show 0.0 (depth counter) to complete. The 糸送 will blink.

While the reel is feeding line with this function, its speed cannot be changed.

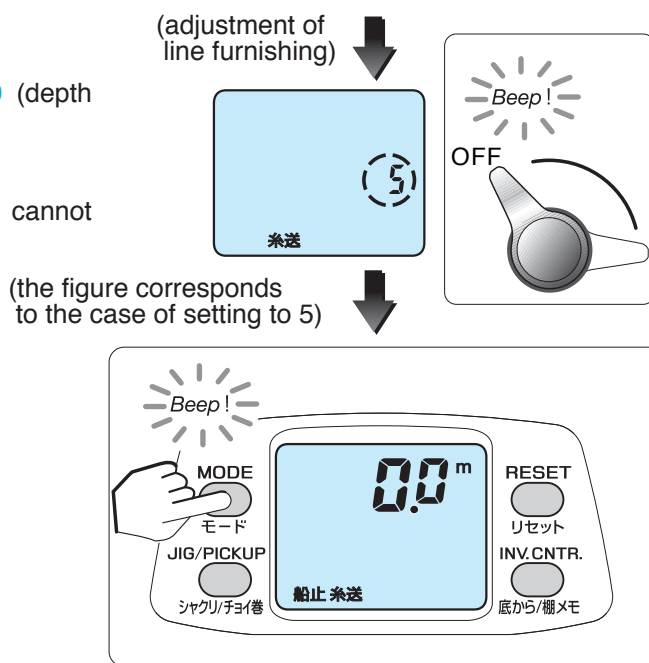

Functional setting operation (5. Pickup speed setting)

Pickup speed preference

1. Press **MODE BUTTON**.

If the display is at **シャクリ** display, then move the power lever or press **RESET BUTTON** to show the display shown on the right.

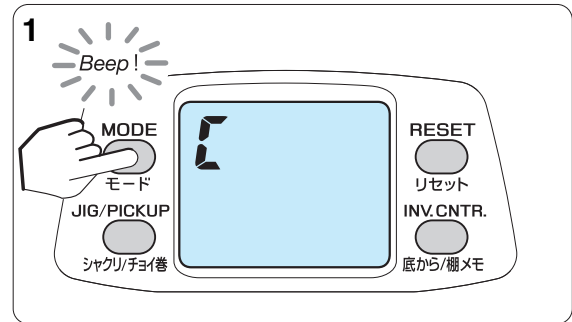

2. Press **MODE BUTTON** again.

This display is the pickup setting display.

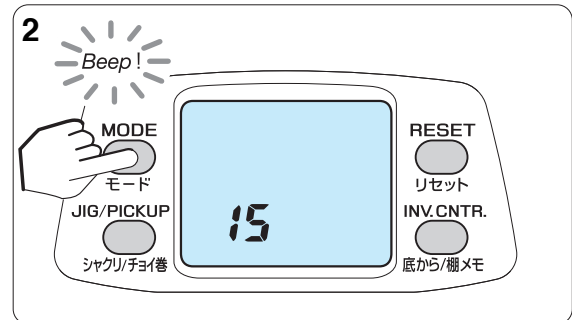

3. Set speed with the power lever.

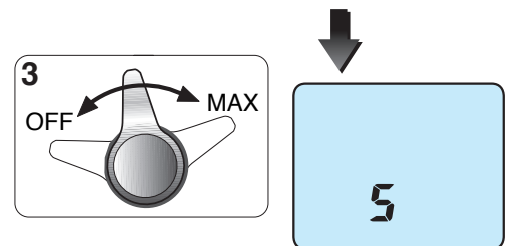

(the figure corresponds to the case of setting to 5)



While the power lever is at MAX position, pressing the **PICKUP BUTTON** makes the motor run at the pre-set pickup speed.

Use

4. Press the **MODE BUTTON** to go back to depth readout.

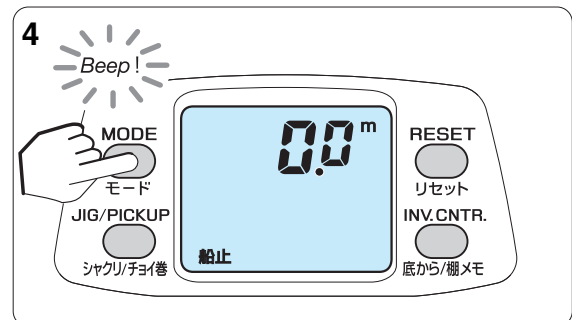

1. While the **PICKUP BUTTON** is in use for winding, winding speed is not displayed.

Attention

Functional setting operation (6. Inverse counter)

Inverse counter

Two counters are better than one. This reel has counters from both the surface and from the bottom.

The default inverse counter setting is OFF. To turn it ON, see page 28. In the following example, intended fishing range is 94 m, which is 6 m from the bottom.

1. Clutch OFF to send the rig to the bottom

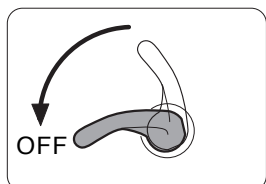

2. At the bottom, move the clutch to ON by turning the reel handle or flipping the clutch lever.

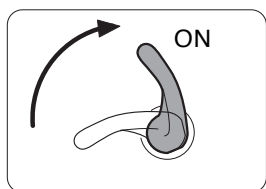

3. After winding up any slack line, press the **INVERSE COUNTER BUTTON** and wind up 6 m.

By pressing the **INVERSE COUNTER BUTTON**, the lower area counter is reset. Wind line until the intended depth is reached.

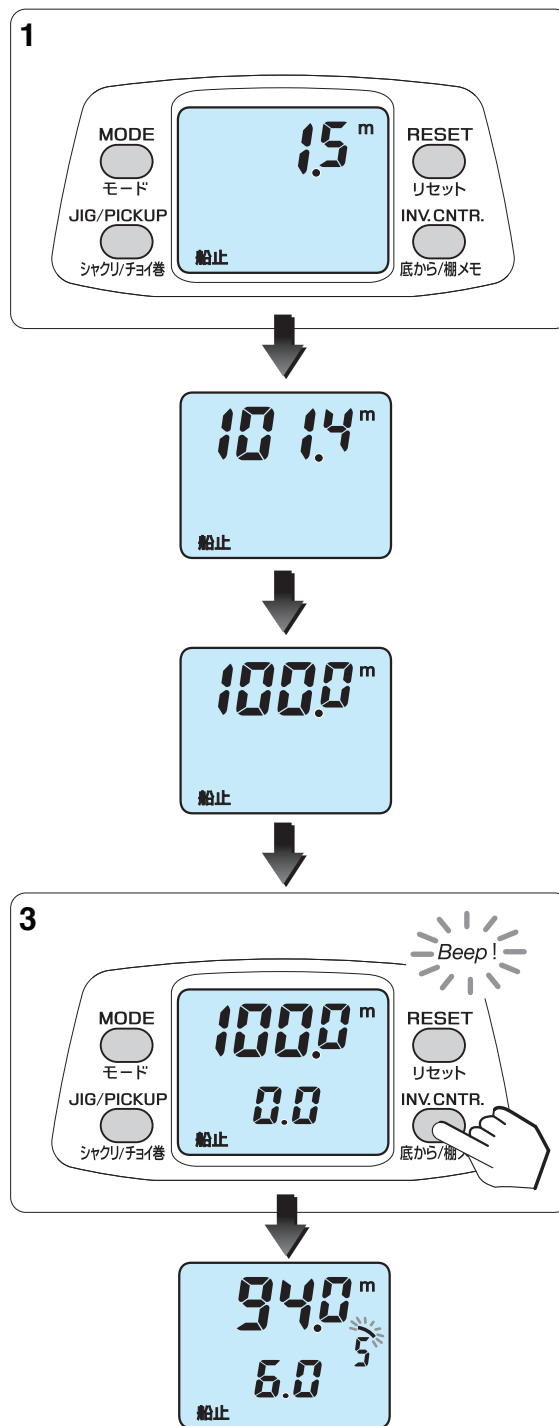

Use

By pressing the **INVERSE COUNTER BUTTON**, the timer starts and keeps an accurate record of fishing time.

Functional setting operation (7. Jigging)

Jigging

Jigging is an extremely valuable function.
After setting your preferences, pressing the **JIG/PICKUP BUTTON** starts the function.
Speed of the jigging can be adjusted with the power lever.

1. Press the **MODE BUTTON** to show pickup / jigging display.

(When jigging is chosen, the pickup function cannot be used.)

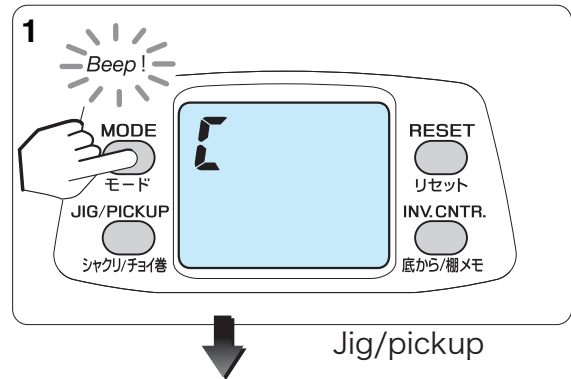

2. Jigging pattern is selected with the power lever.

There are four patterns; 123 (master), 1 step, 2 steps, 3 steps.

Jigging setting displays appear in the following order;
Pattern (step) > length (m) > waiting time (sec) > range (m)

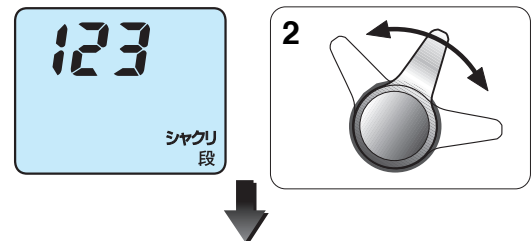

3. Press **MODE BUTTON** to show the next display. Pressing it also locks in the previous setting.

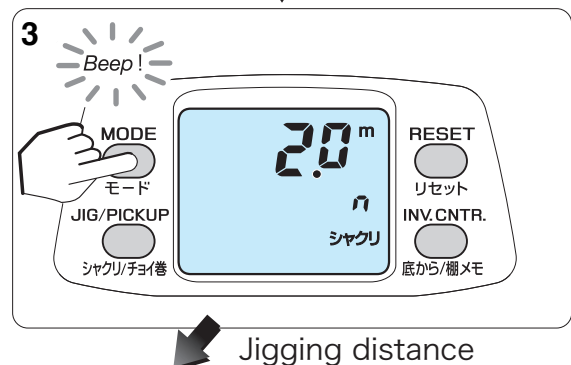

4. In the same manner, set length, waiting time and range.

By pressing the **JIG/PICKUP BUTTON** during the jigging setting display, the display will show depth and begins jigging.

Pressing and holding the **MODE BUTTON** will quickly scroll you back to the depth counter display.

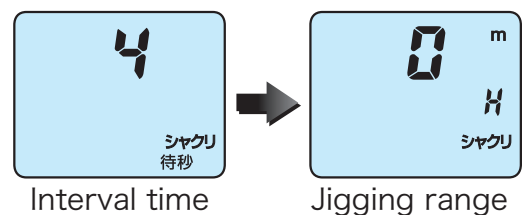

5. After pressing the **JIG/PICKUP BUTTON**, use the power lever to start jigging.

Jigging speed is controlled with the power lever.
As the jerking starts, **シャクリ** indicator blinks.
Pressing the **JIG/PICKUP BUTTON** again stops jigging.

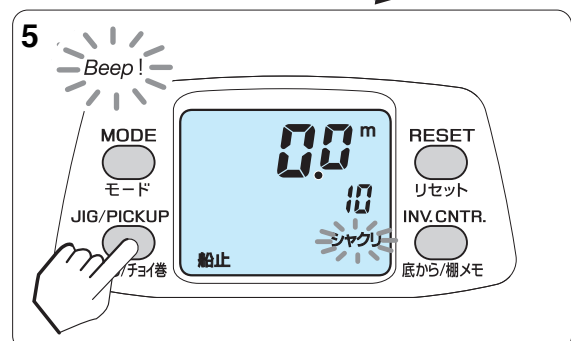

Functional setting operation (7. Jigging)

Jigging master

You can choose the jigging pattern, range, waiting time and length you require.

- Pressing the **JIG/PICKUP BUTTON**, starts jigging, with the display showing the **シヤクリ** indicator. (Pressing the button once more cease jigging.) The power lever controls jigging speed.
- Shifting of jigging speed is done easily with the lever control.
- When a fish strikes during jigging, it turns off providing the power lever is turned to the OFF position. After that, normal winding is done with the power lever.
- To show the jigging display, refer to page 18.

1. Jigging pattern

You can choose the number of steps you wish for your jigging pattern.

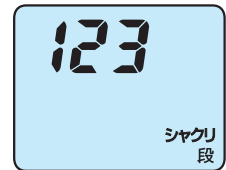

(Preference setting)

One-step jigging	Two-step jigging	Three-step jigging	Master jigging

Master jigging (123) is the method in which the number of jigging steps is selected automatically by the computer.

A : 4 seconds stop
B : 0.4 seconds stop

2. Jigging length

You can choose the length of the line wound up in one jig action. (Depending upon the sinker, speed of winding, the jigging length may overrun its setting slightly.)

The length can be set in increments of 50 cm between 0.5 and 10 m.

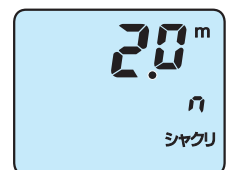

(Preference setting)

Functional setting operation (7. Jigging)

3. Waiting time

You can choose the waiting time between jigs. The interval time is set in seconds.

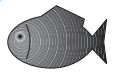

Example

Three-step jigging
5 seconds interval time

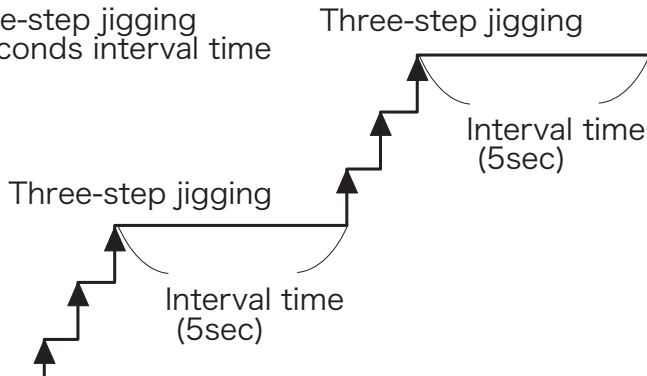

(Preference setting)



(Shown is the interval time set to 5 sec)



- If jigging time is longer than the chumming timer setting, then the chumming timer setting takes priority and will wind up the line.



Attention

4. Jigging range

The depth range for jigging is set in 1 m increments. If the range is set to zero, then jigging continues right up to the auto stop depth.

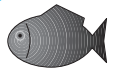

Example

Range is 20 m.

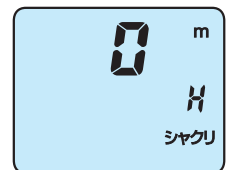
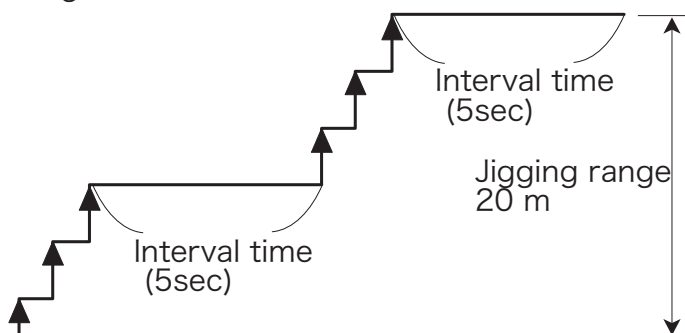

(Preference setting)



(Shown is the jigging range set to 20m)

Functional setting operation (8. Winding speed indicator)

Winding speed display

In the default setting, the lower area counter displays the winding speed.

The chumming timer display area shows the remaining time until the auto stop is reached. (p. 29)
The inverse counter numbers can be changed to indicate winding speed.
Rate of speed indicated is meters per minute (m/min).

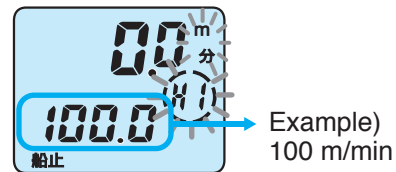

1. Press **MODE BUTTON** to show speed indicator display. **99** is shown on the screen.

In the default setting, the inverse counter is OFF.

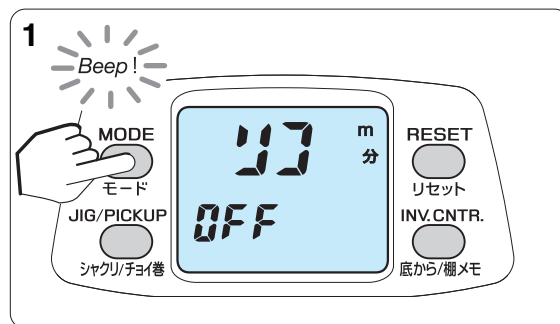

2. Turn it ON with the power lever.

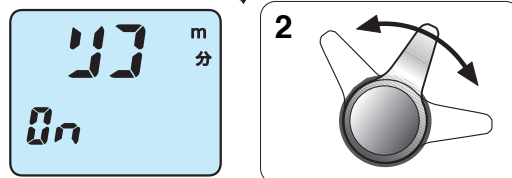

3. Press the **MODE BUTTON** to display the next setting display.

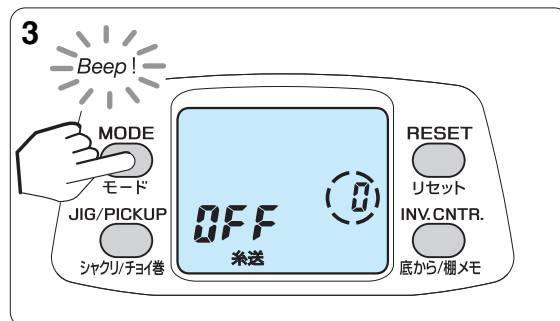

4. Press the **MODE BUTTON** three times to show the water depth on the display. The depth counter will then start to function.

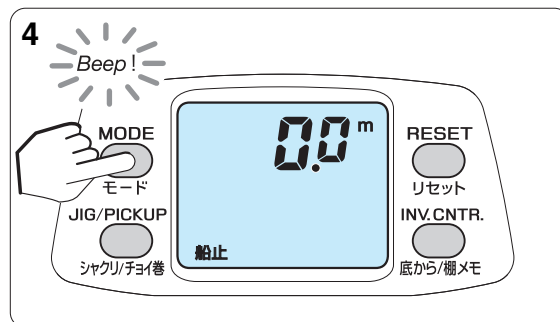

Functional setting operation (9. Remaining time to auto stop)

Displaying of the remaining time to auto stop

Two counters are better than one. This reel has counters from both the surface and from the bottom.

When the display is set to indicate the actual speed, the chumming timer display portion indicates the remaining time before it reaches the auto stop position. However, the display will go out about five seconds before reaching the auto stop position.

This function works if the remaining time is within 7 minutes. If the remaining time is more than 7 minutes, then the partial circle icon blinks.

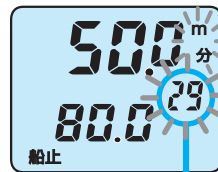

Example)

To wind up from 50 m depth to the auto stop depth, it takes 29 seconds at the speed of 80 m / min.

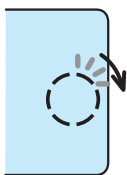

(display example)

- Digits show seconds.
- Each partial circle stands for one minute.



Remaining time; 2 min 30 sec



Remaining time; 5 min 30 sec

- If you would not like the display to show the remaining time before reaching the auto stop position at ship side, please set the depth counter mode ON.(see page 28)
- You cannot put out only the remaining time before reaching the auto stop position.

Functional setting operation (10. Chumming timer winding)

Chumming timer winding

The right timing for the best results. After a pre-determined amount of time has passed, the reel starts winding automatically.

- After pre-set 5 minutes have passed, the reel automatically winds up.
- When the timer is set, the timer indicator **タイマー** is shown in the display. To stop using the timer, set its time to zero.
- Pre-set time can be confirmed by pressing the **INVERSE COUNTER BUTTON**.
- Winding of the chumming timer functions when the depth counter indicates between +20m and -20m. It will not function any more if once the indication of the depth counter goes out of this range.

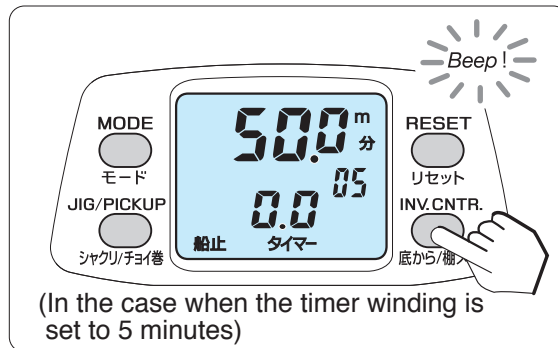

1. Press **MODE BUTTON** until you come to the timer setting display.

タイマー is on the screen. The default setting is zero minutes or **OFF**.

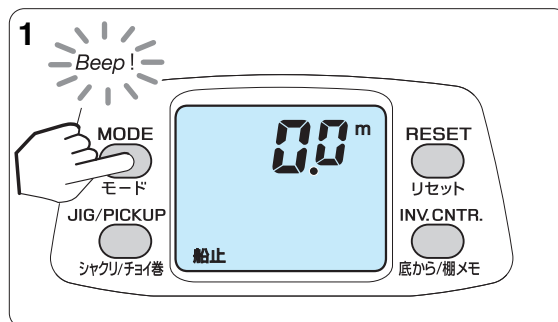

Use

The chumming timer helps ensure you check baits at even intervals, a real help when dropping multiple lines.

2. Use the power lever to set the number of minutes. (Shown is the timer set to 3 minutes.)

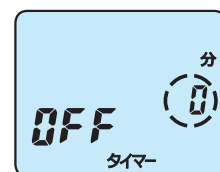

(timer setting display)

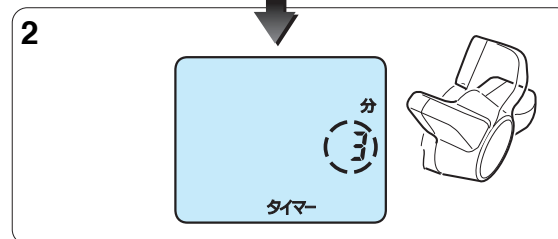

Functional setting operation (10. Chumming timer winding)

3. Press **MODE BUTTON** twice.

- When the display goes back to depth counter, then the procedure is completed.
- The **タイマー** indicator is seen on the display.
- The time set can be checked by pressing the **INVERSE COUNTER BUTTON**.
- Pressing and holding down the **MODE BUTTON** scrolls quickly back to the depth display.

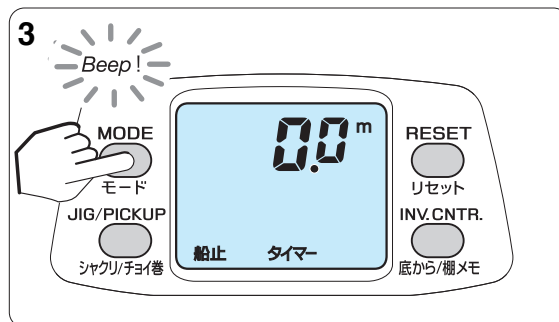

4. When the set time is reached, the reel begins to wind at its maximum speed.

An audible alarm sounds.

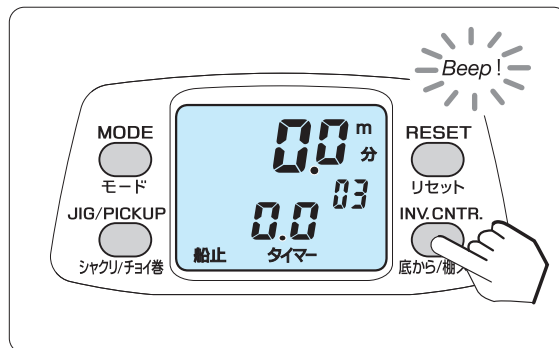

Chumming timer

This function provides a useful timer.

- This function displays the time passed after the presentation of your bait or lure. It can be used for chumming, jigging timing or reeling in your rig.
- The chumming timer starts from 7.0 m on the counter, unless a specific fishing range has been entered into memory. Display time is shown in seconds if remaining time is less than 60 seconds, in minutes if remaining time is more than a minute.

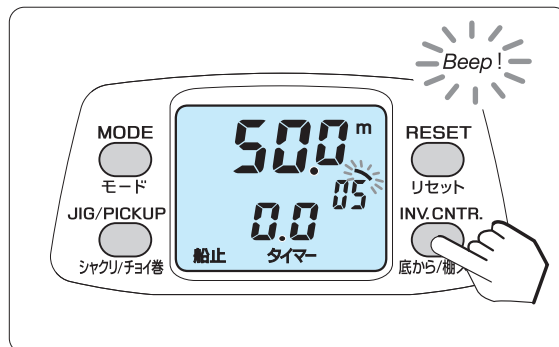

Counter initially shows seconds, after 1 minute, indicates minutes.



The outer frame expresses 10 seconds with each arch segment.



1. Pressing the **INVERSE COUNTER BUTTON** while the timer is in operation re-starts the timer from **0.0**.

Functional setting operation (11. Display recalibration)

Display revision

You can recalibrate the counter should it not indicate an accurate depth compared to depth markings on your line.

Example below is the case in which, though the counter shows 103 m, color markings on the line indicate 100 m.



1. Press **MODE BUTTON** six times to show on the display real fishing time and total winding length.

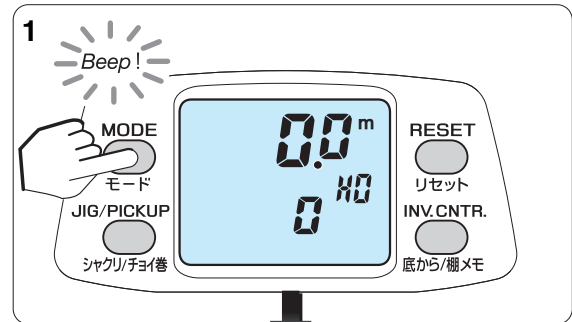

2. Press **MODE BUTTON** and **RESET BUTTON** at the same time for 2 seconds. This displays revision display.

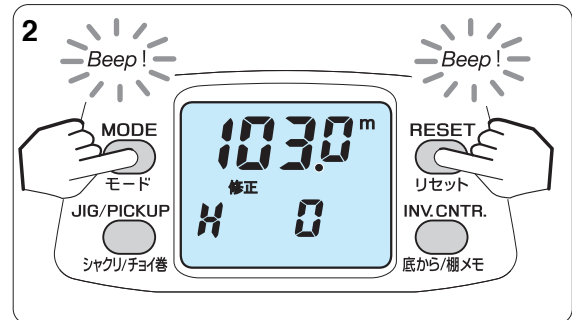

3. Move the power lever to change the display's reading to 100.0. (Occasionally, for the revision rate, the exact number cannot be attained.)

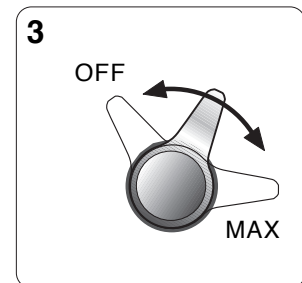

4. After 100.0 is reached, then press the **MODE BUTTON** to return to depth display. With this procedure, the inverse counter is reset. In the revised display, pressing of the **RESET BUTTON** changes the reading back to the unrevised value.

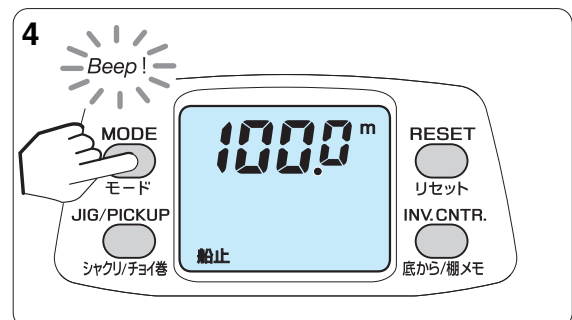

Functional setting operation (12. How to fix the Rod Clamp)

When you use a metallic bat or for your fishing of a big charge, you should always utilize the Rod Clamp.
(sing the Rod Clamp, it is possible to cramp rods with diameter up to 25-34mm)

1. Insert the Bolt in the clamp setting hole, and fix it by tightening the Nut and the Washer.

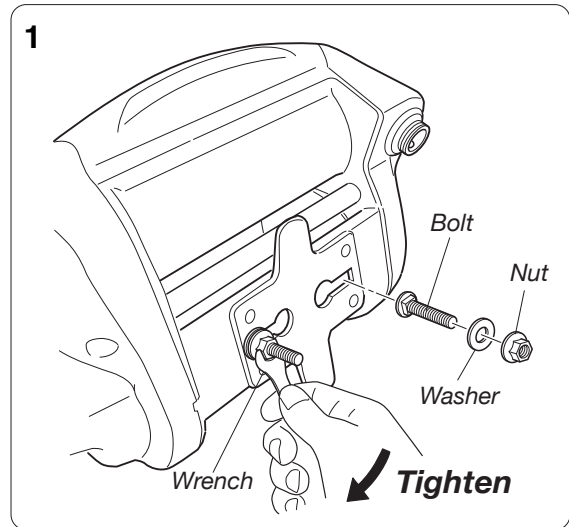

2. Hold the rod in position while attaching the clamp.
Tighten the rod clamp nuts to secure.

To fix the reel with a rod clamp apply the screws to the reel foot then place the rod between the threads then add the clamp and tighten the nuts.

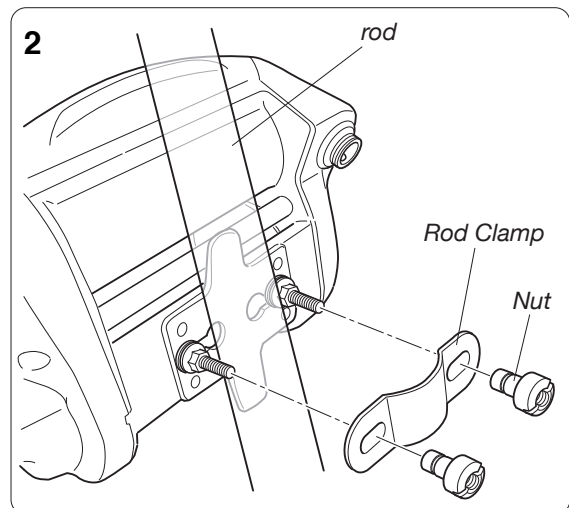

Attention

- If the Nut is tightened too firmly, there is a danger of deforming the rod depending upon rod material, especially with composite rods and reel seats.

Useful functions

Various alarms

Many kinds of information are indicated by audible alarms.

Power lever alarm

- Placing the Power lever at MAX or OFF positions evokes an alarm.



Auto stop alarm

- While winding up, starting 6 m below the auto stop depth, an alarm beeps at two meter intervals. Upon reaching the auto stop depth, a long alarm sounds.

Range memory alert

- While lowering your rig back into the strike zone, starting 6 m above the memorized strike depth, an alarm sounds at two m intervals with a long alarm sounding once the target depth is reached.

(This range memory alarm does not sound unless line has been wound more than 6 m above the memorized depth.)

Switch alarm

- Each time a button is pressed, a confirming beep is sounded.

Excessive voltage alarm

- Should you attach a power source with a voltage higher than the acceptable level, a continuous alarm will sound. DO NOT operate the reel. Disconnect the power source. Connect a power source with the proper voltage.

Timer alarm

- Chumming timer winding is indicated by an alarm.

Display light

Backlighting of the display provides easy reading for early morning or night fishing.

Backlighting of the display provides easy reading for early morning or night fishing.

- As long as the reel is connected to a power source, the display backlight is on.

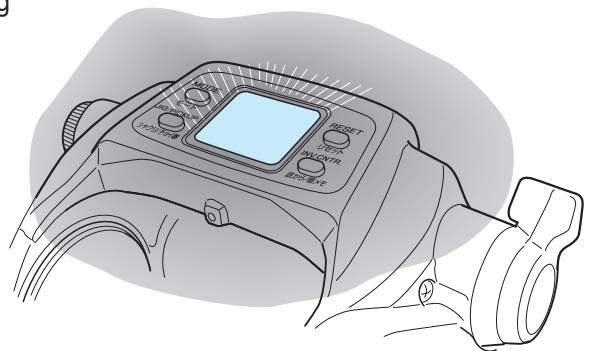

Breaker display

- For safety, an excessively heavy load on the reel will activate the circuit breaker system and stop automatic winding. While this system is working, the display appears as shown on the right.

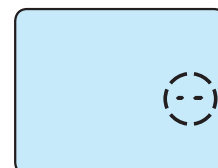

Reel Specifications

Reel Specification list

Product name	TANACOM BULL 1000		
Product code	40801001		
Gear ratio(manual winding)	2.3 : 1		
Weight (g/oz)	1530 g / 54 oz		
Max Drag power (kg/lb)	22kg/48lb		
Line Capacity (m)	DAIWA BRAIDED	MONO	BRAIDED
	PE6(80lb)-1000m(1100yds)	30lb-700m(770yds)	60lb-1000m(1100yds)
	PE8(100lb)-800m(880yds)	40lb-500m(550yds)	80lb-800m(880yds)
	PE10(120lb)-600m(660yds)	—————	100lb-600m(660yds)
	PE12(150lb)-500m(550yds)	—————	120lb-500m(550yds)
Number of Ball bearings	4		
Range of acceptable voltage	DC 12 V – 16.8 V		
Max winding speed (no load)	130 m / min		
Normal max winding speed (1.5kg load)	Approximately 110 m / min		
Instant max winding power	70 kgf		
Electric current (Amps)	No load	3	
	stall	10	
	Max	30	
Speed shifting	No load	0 – 130 m / min (continuous shifting)	

- Hi speed (no load) = power voltage 12 V, maximum speed of winding at spool fully wound.
- Normal max winding speed = 1.5kg load, the average speed of 100 m winding.
- Instant max winding power = power voltage 12 V, smallest radius of spool.

Counter display

Depth display range	Upper counter; 0.0 – 999.9 m Lower counter : -99.9 – 999.9 m
Usable temp. range	-10 to +60 (degrees centigrade)

Specifications may be changed without prior notice for the purpose of improvement.

Parts List

TANACOM BULL1000

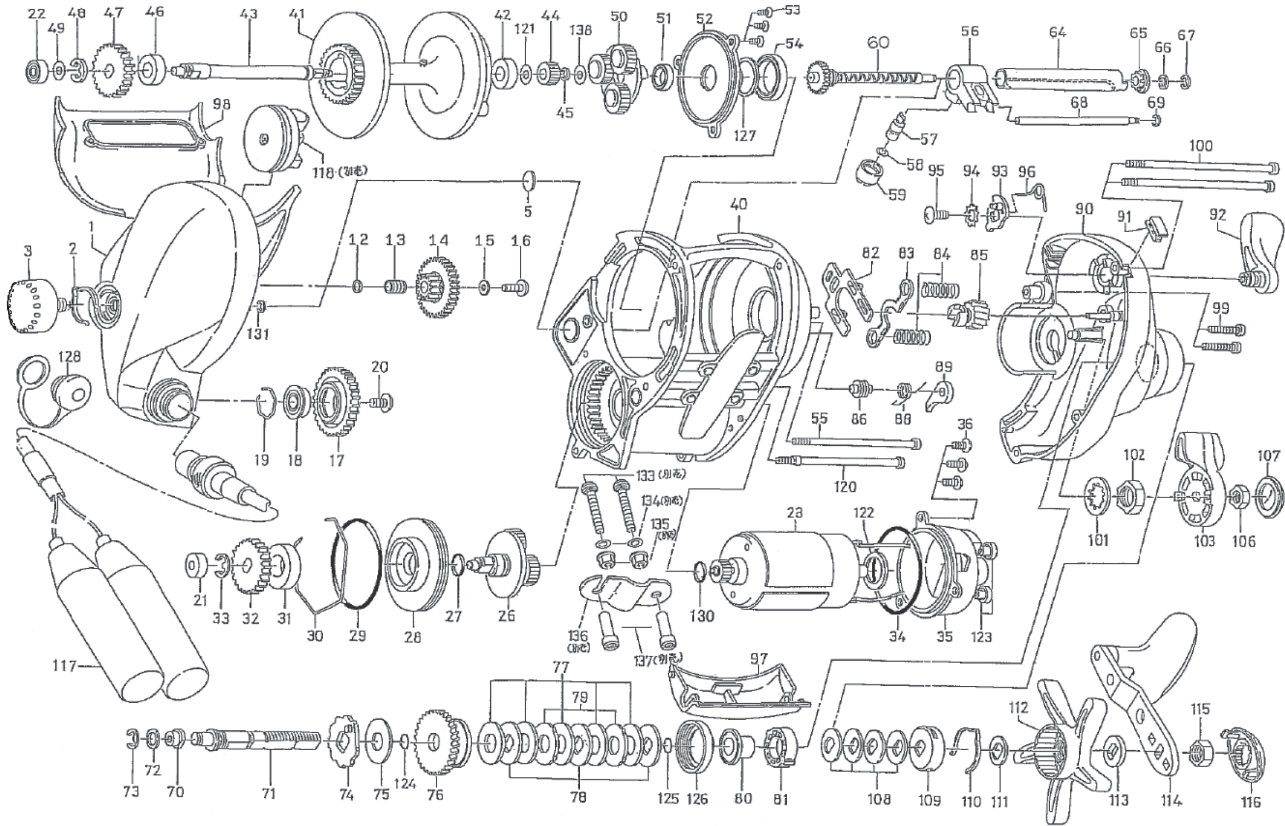

TANACOM BULL1000

No.	Parts No.	Parts Name	No.	Parts No.	Parts Name	No.	Parts No.	Parts Name
1	6H377801	IC MODULE L/S PLATE SET	56	6G812101	LEVELWIND	107	6F430002	POWER LEVER COVER
2	6E033201	BRAKE CLICK SPRING	57	61220601	LEVELWIND PAWL	108	6E253501	DRAG SPRING WASHER
3	6E489621	BRAKE ADJ KNOB	58	6F774600	LEVELWIND WASHER	109	6F470002	DRAG HOLDER
5	6G225102	MECHANICAL BRAKE WASHER	59	6E354101	LEVELWIND NUT	110	6B747702	DRAG HOLDER LEAF SPRING
12	6E096504	IDLE GEAR (A) WASHER	60	6G835401	WORM SHAFT	111	6F470101	DRAG HOLDER WASHER
13	6H439801	IDLE GEAR (A) COLLAR	64	6G362801	WORM SHIELD	112	6F550415	STAR DRAG
14	6H439901	IDLE GEAR (A)	65	6F467201	WORM SHAFT BUSHING (R)	113	6F470303	HANDLE COLLAR
15	6F571902	IDLE GEAR (A) SCREW WASHER	66	6B411706	WORM SHAFT WASHER	114	6G678101	HANDLE
16	63517706	IDLE GEAR (A) SCREW	67	63205901	WORM SHAFT RETAINER	115	6B862102	HANDLE NUT
17	6G225201	IDLE GEAR (B)	68	6G362901	LEVELWIND POST	116	6F471205	HANDLE CAP
18	6G070301	IDLE GEAR (B) BALL BEARING	69	6B864101	LEVELWIND POST RETAINER	117	6Z018327	ELECTRIC POWER CORD
19	6G070201	IDLE GEAR (B) RING	70	6E252501	DRIVE SHAFT BUSHING	118	6Z010626	INPUT ROLLER
20	63538207	IDLE GEAR (B) SCREW	71	6F715302	DRIVE SHAFT	120	6G363101	FRAME SCREW (B)
21	66375601	MOTOR GEAR (A) BUSHING	72	63755801	DRIVE SHAFT WASHER	121	63716906	SPOOL SHAFT BUSHING WASHER (B)
22	66372102	SPOOL SHAFT BALL BEARING	73	63207601	DRIVE SHAFT WASHER RETAINER	122	6F701201	MOTOR WASHER
23	6G811901	MOTOR	74	6F597301	RATCHET	123	6G173401	CORD SHIELD
24	6G385901	MOTOR SCREW	75	63746604	DRIVE SHAFT WASHER (B)	124	6F657801	DRAG O RING
25	6E292901	MOTOR GEAR (A) BUSHING	76	6G812001	DRIVE GEAR	125	6F657801	DRAG O RING
26	6G141302	MOTOR GEAR (A)	77	6B360209	EARED WASHER	126	6F817001	DRAG COLLAR SHIELD
27	6F714801	MOTOR GEAR (A) O RING	78	63723833	DRAG DISC WASHER	127	6F682600	SPOOL PLATE WASHER
28	6F739601	MOTOR CASE PLATE	79	6B360302	DRAG LIP WASHER	128	6F661002	CONNECTOR CAP
29	6F595801	MOTOR CASE O RING	80	6G829001	DRAG COLLAR (A)	130	6G488801	MOTOR O RING
30	6F595901	MOTOR CASE RING	81	6F715601	DRAG COLLAR (B)	131	6F078301	MOTOR HOLDER BUSHING
31	6F739701	MOTOR CASE BUSHING	82	6F597001	YOKE PLATE	132	6B270501	MOTOR HOLDER BUSHING RING
32	6G225701	MOTOR GEAR (B)	83	6E290601	YOKE	133	6F187601	CLAMP SHAFT SCREW
33	63201611	MOTOR GEAR (B) RETAINER	84	6G473401	YOKE SPRING	134	6B937802	CLAMP SHAFT WASHER
34	6F595301	MOTOR HOLDER O RING	85	6F740201	PINION GEAR	135	6F187801	CLAMP SHAFT NUT
35	6G362601	MOTOR HOLDER	86	6F773001	SPRING HOLDER	136	60419901	CLAMP PLATE
36	63516101	MOTOR HOLDER SCREW	88	6F608301	ANTI-REVERSE PAWL SPRING	137	63425301	CLAMP PLATE NUT
40	6G382502	FRAME	89	6F597201	ANTI-REVERSE PAWL	138	6F774600	SPOOL GEAR WASHER
41	6G811501	SPOOL	90	6G812601	R/S PLATE	139	63205901	MECHANICAL BRAKE KNOB RETAINER
42	6F713701	SPOOL SHAFT BUSHING (A)	91	6E286001	LINE HOLDER	200	6Y493803	MANUEL CD-R
43	6G811701	SPOOL SHAFT	92	6F469006	CLUTCH LEVER			
44	6G126402	SPOOL SHAFT GEAR (A)	93	6F597901	CLUTCH CAM			
45	63205901	SPOOL GEAR RETAINER (A)	94	61608001	CLUTCH LEVER WASHER			
46	6F713701	SPOOL SHAFT BUSHING (B)	95	63538212	CLUTCH LEVER SCREW			
47	6G225701	SPOOL SHAFT GEAR (B)	96	6F598201	CLUTCH CAM SPRING			
48	63201611	SPOOL GEAR RETAINER (B)	97	6G374502	MOTOR COVER			
49	6B411700	SPOOL SHAFT GEAR (B) WASHER	98	6G374802	FINGER COVER			
50	6G811801	MOTOR GEAR(D)	99	63538705	R/S PLATE SCREW(A)			
51	6G156801	MOTOR GEAR(D) BALL BEARING	100	6G405901	R/S PLATE SCREW(B)			
52	6F594104	SPOOL PLATE	101	6F285901	POWER LEVER WASHER			
53	6F206901	SPOOL PLATE SCREW	102	6F303102	POWER LEVER NUT(A)			
54	6F389102	SPOOL PLATE BALL BEARING	103	6F429701	POWER LEVER			
55	6G363001	FRAME SCREW (A)	106	63424004	POWER LEVER NUT(B)			

There may sometimes be a difference between the purchased reel and the Dismantled Parts Chart or the parts list above due to the adjustment process etc. We appreciate your understanding.

Trouble shooting

Symptom	Possible causes	To do	Ref. page
Motor does not respond to the power lever	The counter displays 0.0 m.	It is a normal function to avoid over winding. Press RESET BUTTON to continue winding.	21,22
	Did not pull the lever to OFF position.	Pull the lever to OFF and then move forward again to start winding.	9
	Unstable power source	Use another power source, such as electric reel specific batteries.	2
Counter display does not appear.	Battery charge is low.	Recharge the battery.	3
	Cord worn or corroded	Replace the cord.	5
	Incorrect battery connection	Connect correctly.	2
Inverse counter does not appear	Did not press JIG/PICKUP BUTTON	It is normal. Press INVERSE COUNTER BUTTON .	24
	Inverse counter is OFF (default setting)	Using MODE BUTTON , change the setting of this function.	28
Jigging function does not respond	Power lever is at OFF	Push the lever forward.	25
	Pickup mode is selected	With MODE BUTTON , select the jigging mode	25-27
The reel jigs on its own.	Low power voltage	Replace with a recharged battery.	3
Auto stop function does not work	Did not press RESET BUTTON at surface	Press RESET BUTTON to reset depth to zero with rig at the surface.	20
	Error for sinker weight or rocking of the boat	Adjust settings of auto stop function.	21,22
	Line is elongated.	Reset the depth counter at the surface.	20
There are counter errors.	Line length has increased due to stretching.	<ul style="list-style-type: none"> - Reset the counter. - Revise the display. - Re-enter line data. 	20 32 10-17
Pickup does not respond.	Speed setting is at zero	Press MODE BUTTON to select winding speed setting.	23

Contact your dealer if the reel does not function properly despite the above details being confirmed, in the event of other problems arising, and to order parts.

Reference/Référence/Hinweis Instrucciones/Riferimenti

COMPANY NAME	DAIWA SPORTS LIMITED
ADDRESS	Netherton Industrial Estate, Wishaw ML2 0EY, Lanarkshire, Scotland, U.K.
TEL NO.	01698-355-723
Web Address	http://www.daiwasports.co.uk/

COMPANY NAME	DAIWA FRANCE S.A.S
ADDRESS	25 BOULEVARD INDUSTRIEL BP 30208 76304 SOTTEVILLE LES ROUEN CEDEX. FRANCE
TEL NO.	02-32-91-96-50
Web Address	http://www.daiwa-france.fr/

COMPANY NAME	DAIWA CORMORAN SPORTARTIKEL-VERTRIEB GmbH
ADDRESS	Industriestrasse 28 82194 Groebenzell GERMANY
TEL NO.	08142-5005-0
Web Address	http://www.daiwa-cormoran.info/

COMPANY NAME	Daiwa Corporation
ADDRESS	11137 Warland Drive Cypress, CA 90630
TEL NO.	+1-(562) 375-6800
Web Address	http://www.daiwa.com/

COMPANY NAME	Daiwa Australia Pty. Ltd
ADDRESS	Unit K, 134 – 140 Old Pittwater Rd, Brookvale NSW 2100
TEL NO.	+61 (02) 8644 8644
Web Address	http://daiwafishing.com.au/

LIMITED WARRANTY TERMS

WARRANTY WILL EXPIRE WHEN ONE OF THE FOLLOWING HAS BEEN SURPASSED.

*ONE YEAR FROM DATE OF ORIGINAL PURCHASE.

*200 TOTAL HOURS OF USE.

GARANTIE

LA GARANTIE EXPIRE LORSQUE L'ON ATTEINT

*SOIT 1 AN APRES L'ACHAT

*SOIT 200 H D'UTILISATION

TERMINOS DE GARANTÍA LIMITADOS

La garantía caducará cuando algo de lo siguiente se haya sido superado.

*Un año de la fecha de la compra original

*200 horas totales de uso